

Creating a social currency

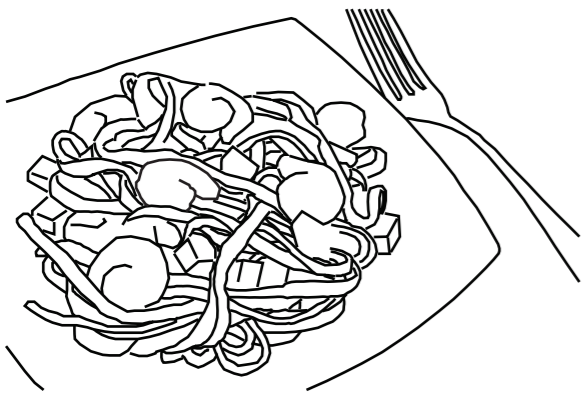

Ingredients

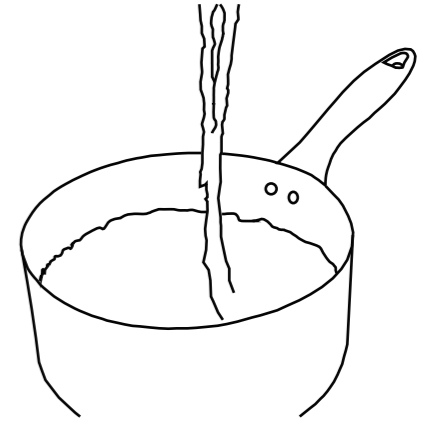
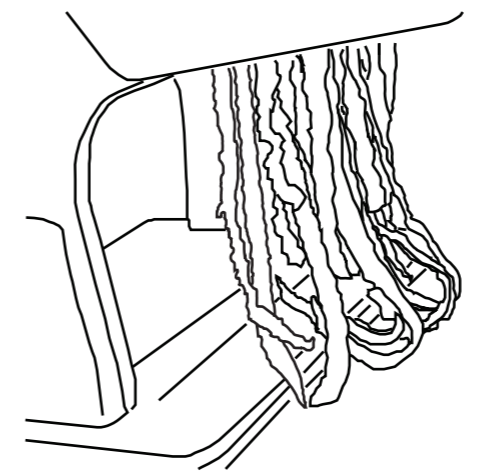
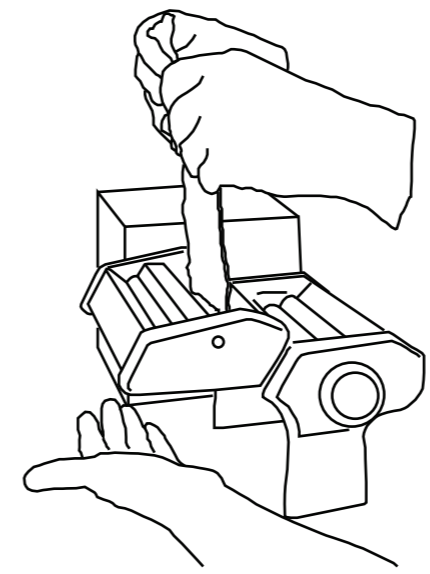
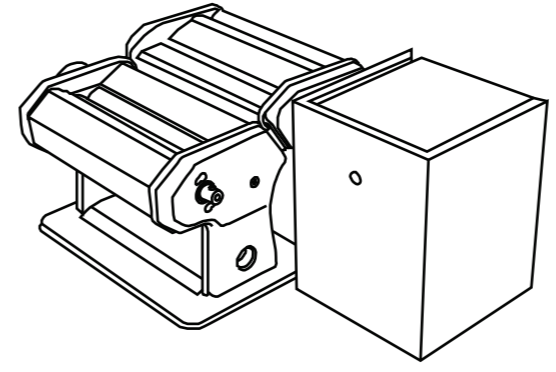
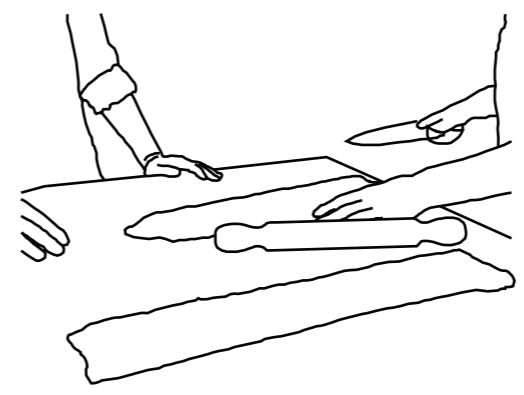
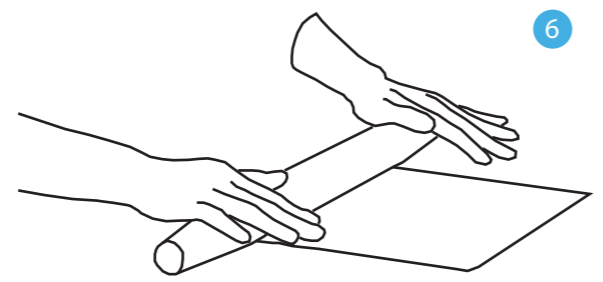
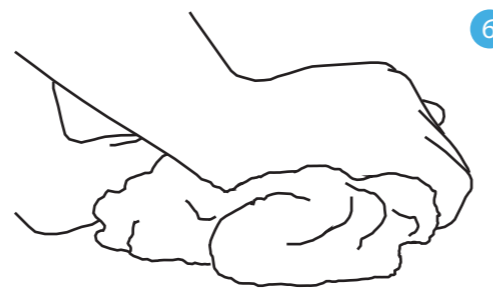
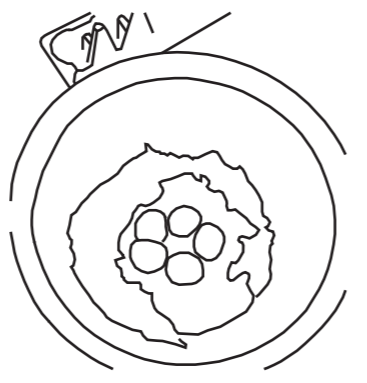
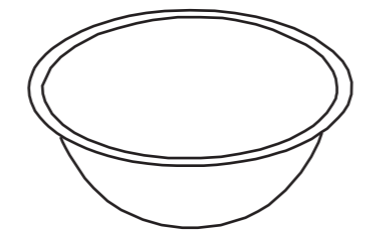
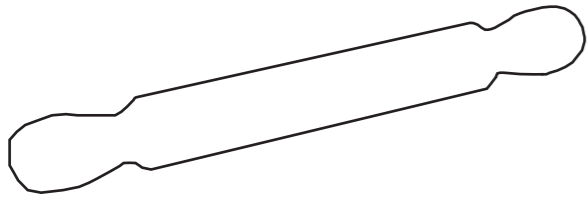
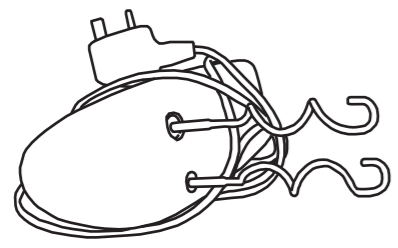
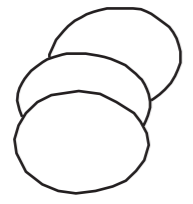
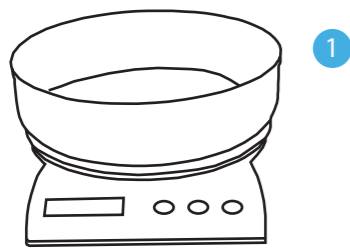

Index

- 1 Electric scales
- 2 '00' flour
- 3 Medium eggs
- 4 Electric whisk
- 5 Rolling pin
- 6 Use Mixing bowl to hold the pasta mix
- 7 Mix 2 eggs and 120grams of 'oo' flour using a whisk
- 8 Knead the flour
- 9 Knead until the pasta is no longer tacky
- 10 Using a rolling pin role the pasta into sheets
- 11 Trim to make it easier to feed into the machine
- 12 Make sure your machine is plugged in and clean
- 13 Feed the pasta sheets into the machine
- 14 Cut pasta to desired lengths
- 15 Cook for approximately 4/5 minutes