

The Glueless, Poseable Cardboard Robot.

by [Kiteman](#) on August 30, 2009

Table of Contents

intro: The Glueless, Poseable Cardboard Robot.	2
step 1: Materials and tools	2
step 2: Templates?	3
step 3: The body	4
step 4: Arms.	5
step 5: Legs.	7
step 6: Head.	9
step 7: Finishing.	11
Related Instructables	11
Advertisements	12

intro: The Glueless, Poseable Cardboard Robot.

OK, maybe not such a good idea for a contest organised by a *glue* manufacturer, but I was inspired.

The whole model is held together with friction, but is (fairly) poseable.

...and it has claws!



step 1: Materials and tools

Most of the robot's body is built of corrugated card, but the forearms and claws are light cardstock, and most of the joints are rolled paper.

The wrist joints need a cocktail stick or toothpick.

I also used 5mm-squared paper for sketching templates, and a sharp craft knife ("Stanley" or "Xacto" type) for cutting the card, and my Leatherman for balancing the half-built beast.

Oh, and a powerdrill. (You'll see...)

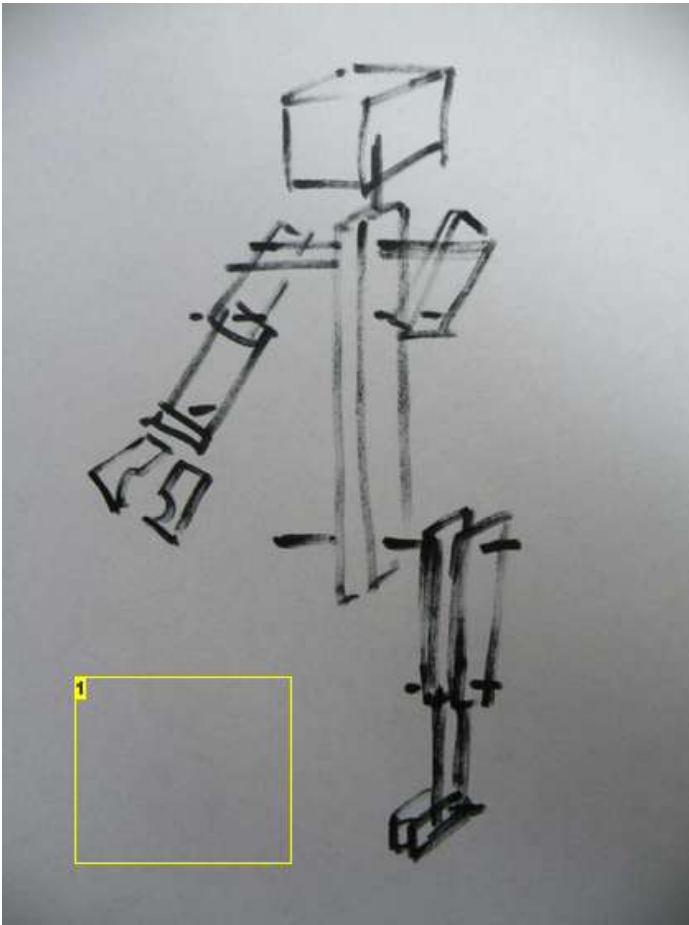

Image Notes

1. This sketch was all I had on paper before starting construction.

step 2: Templates?

Normally, when I make a card or paper model, I can provide templates.

Not this time, because I was working "off the cuff", making it up as I went along.

The templates I used I sketched as I needed and created them, but much of the robot was cut and built by eye. I have added photos of the templates I sketched, to give a little assistance.

As a guide to size:

- The torso pieces (apart from the central one) are all 12cm long and a smidge under 2cm wide.
- The upper arms and forearms are all 6cm long and 2cm wide.
- The leg pieces (thighs and shins) are all 7cm long.
- The squares on the template sketches are all 5mm across.
- The head is a cube, 4cm on an edge.

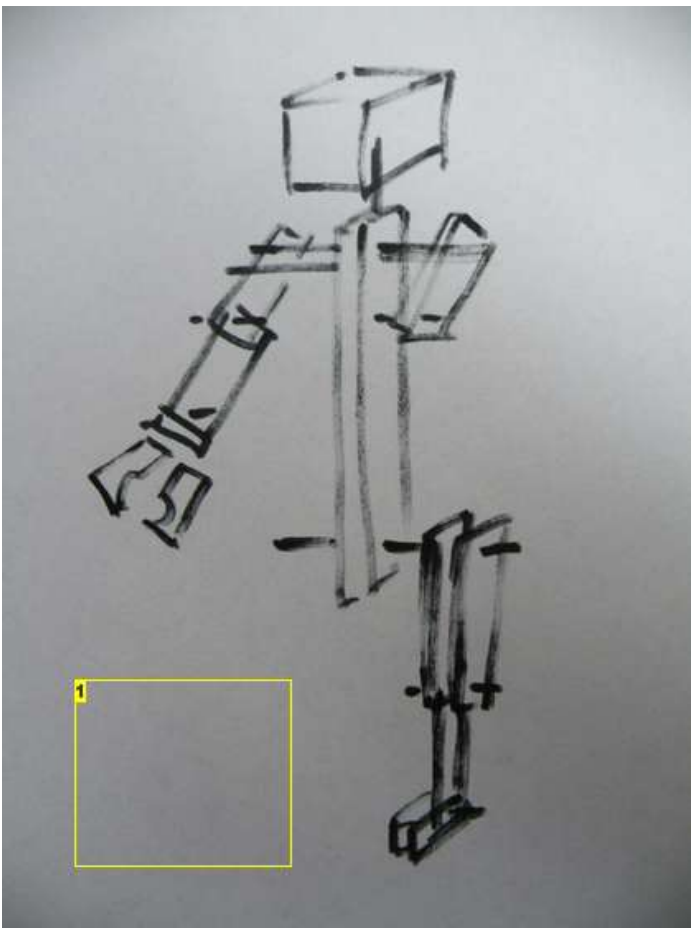

Image Notes

1. This sketch was all I had on paper before starting construction.

step 3: The body

I cut five strips of corrugated card.

Four were 12x2cm, and the fifth was a bit longer to form the neck.

I bunched the strips together, then used my drill-press to put holes in each end. Yes, I drilled loose corrugated card - it's easier than poking sharp things through by a long chalk, and meant that the holes were all identically-placed.

I threaded tightly-rolled pieces of paper through the holes to form shoulders and hips.

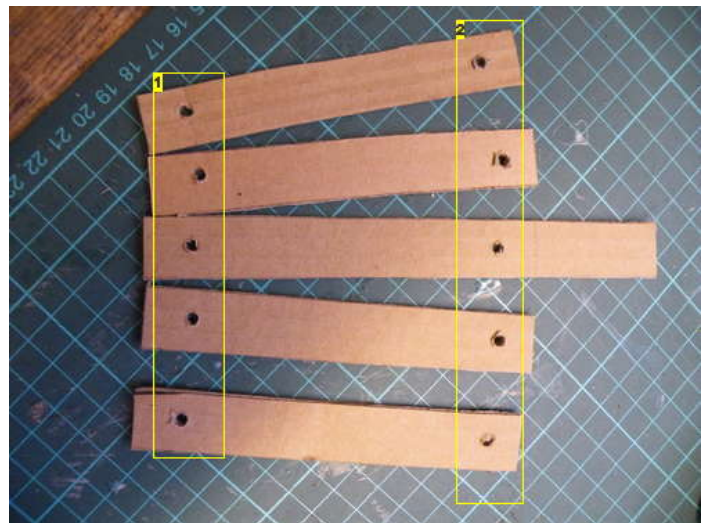
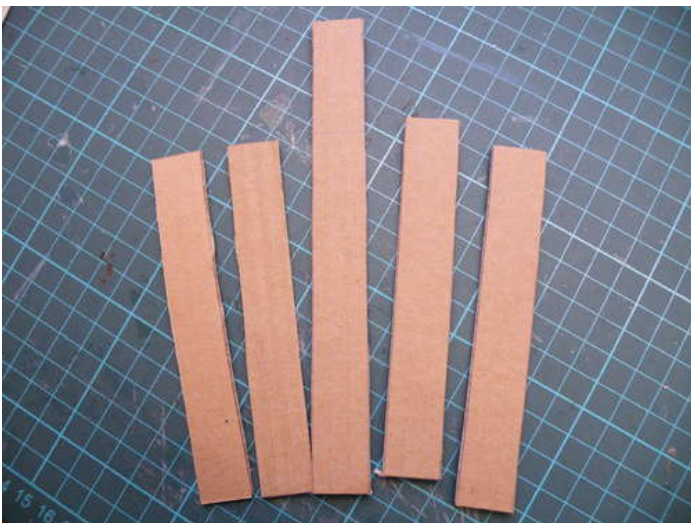

Image Notes

1. Drilled holes for hip-joints.

2. Drilled holes for shoulder-joints.

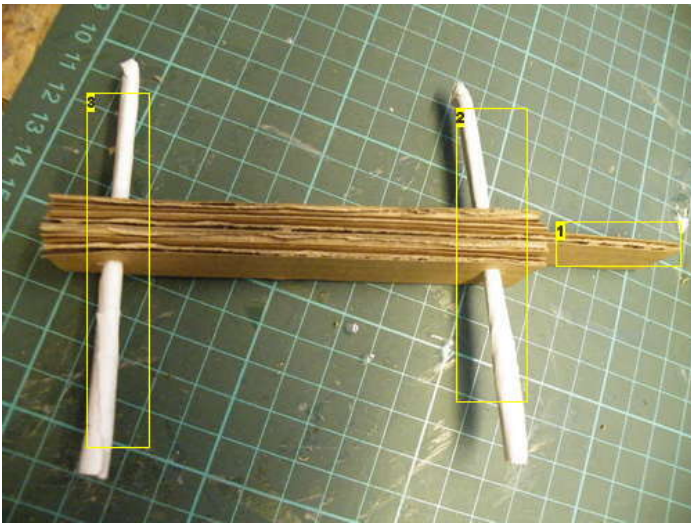

Image Notes

- 1. "Neck"
- 2. Shoulders.
- 3. Hips.

step 4: Arms.

Each upper-arm consists of two pieces of corrugated card, drilled the same as the body was.

I trimmed the elbow-end of the upper arms to a curve to allow the forearms to move. Make sure that the curved section is to the rear of the robot, in the point of the elbow.

The forearms were made of card-stock, to keep the weight down and not over-load the elbow and shoulder joints.

As you can see from the template, they were formed of one piece of cardstock each, folded to create two layers *around* the upper arm at the elbow (which is why the curve was needed).

The slight pointedness of the forearms is purely aesthetic.

The elbow joints were made by threading short, tight rolls of paper through the holes.

The claws are also cardstock, each claw needing two pieces of folded card, from the template shown.

They are held in place with small pieces of cocktail stick, for the sake of tidiness and lightness.

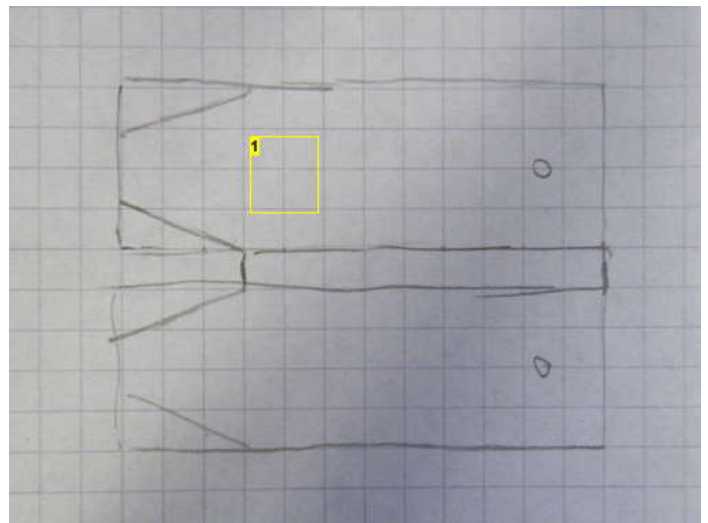

Image Notes

- 1. Template for forearms.

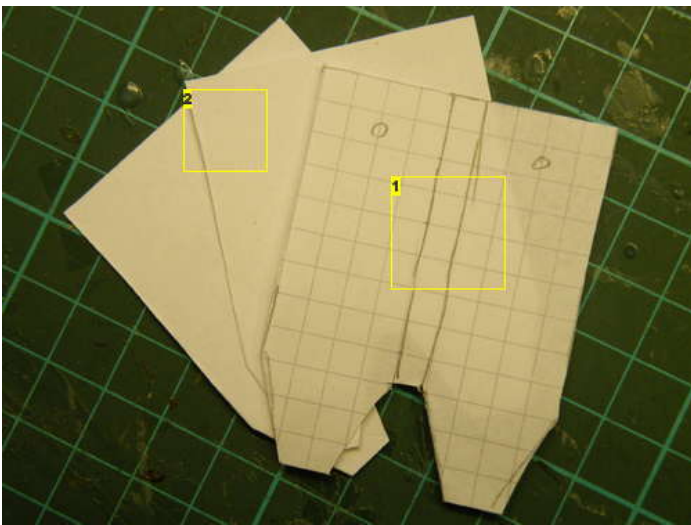

Image Notes

1. Template for one forearm.
2. Cut forearms.

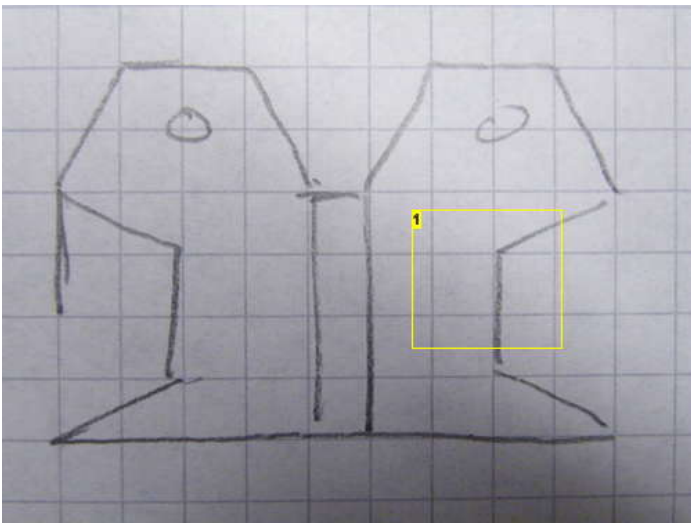

Image Notes

1. Template for claws.

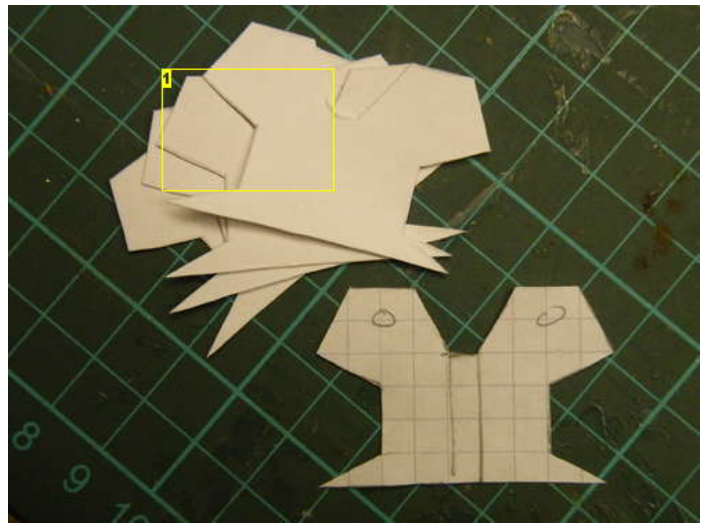

Image Notes

1. You need to cut four pieces for two claws.

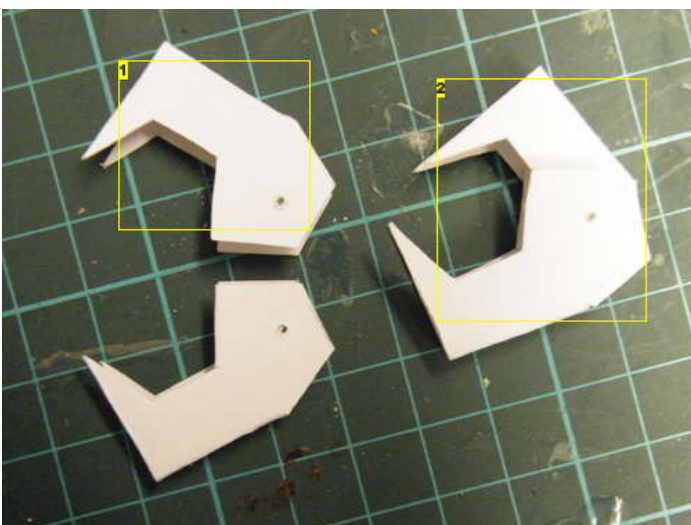

Image Notes

1. Fold each piece like this...
2. ...and fit them together like this.

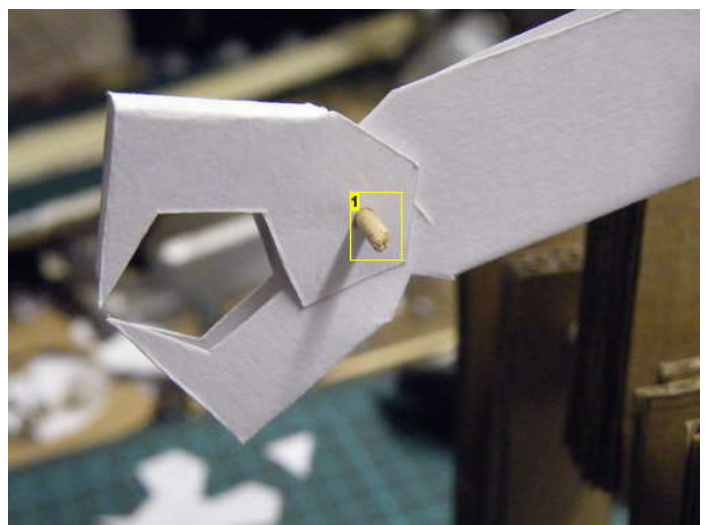

Image Notes

1. A very short piece of cocktail stick.

step 5: Legs.

The legs needed twelve identical pieces, each 2x7cm.

Again, drilled at each end, and jointed with a rolled piece of paper.

I put the legs together before fitting them to the hips, simply because it was easier.

The thighs were formed of four pieces, with the shins fitted in the middle - two for the thigh, two for the shin, two for the thigh.

I then threaded the thighs onto the hips, and moved onto the feet.

The feet were each made of a single piece of corrugated card, folded in half at the toe (see the template), and fastened at the ankle with yet another roll of paper.

The feet looked a bit clumpy and Frankenstein's-monster-like, but they aided balance, and made up for the shortish shins.

- If I were to make another of these, I would make the shin pieces one or two centimetres longer than the thighs, purely to look better.

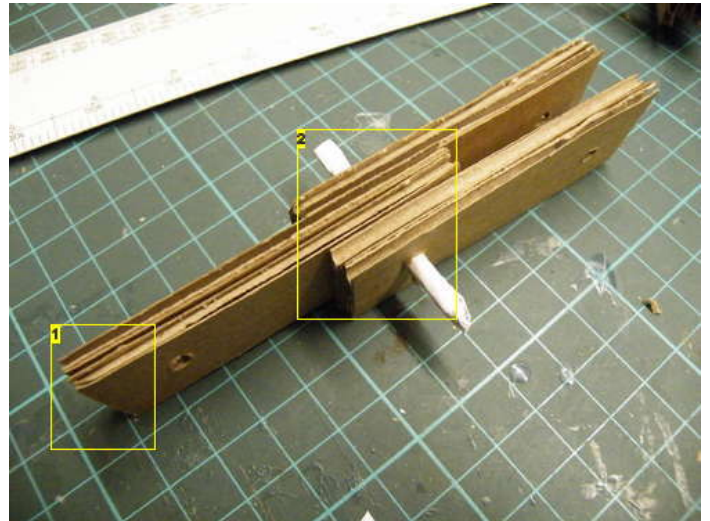

Image Notes

1. The angles are all 90 degrees - the pointedness is an illusion of the camera-angle.
2. Knee.

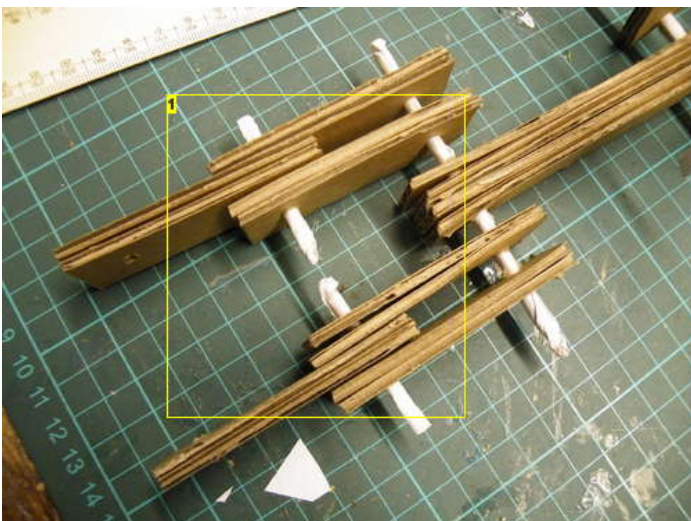

Image Notes

1. Two legs, fitted.

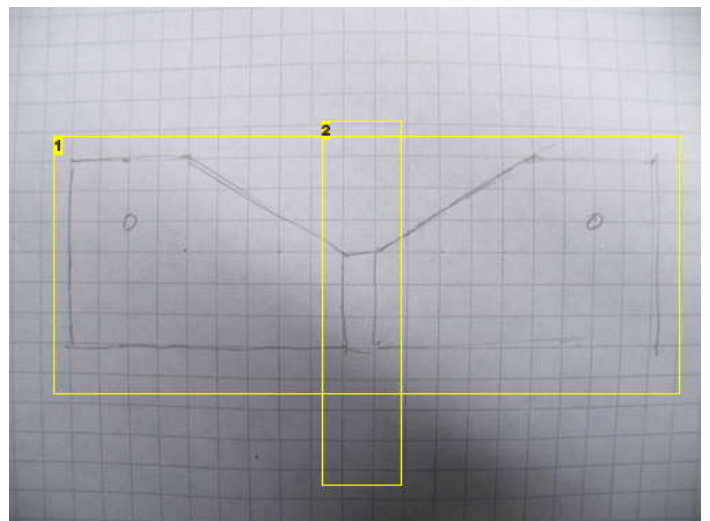

Image Notes

1. Template for one foot.
2. Fold here, at the toe.

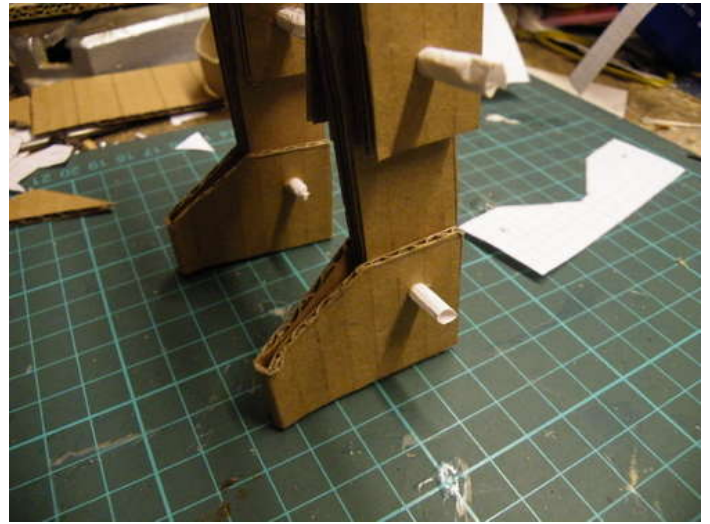
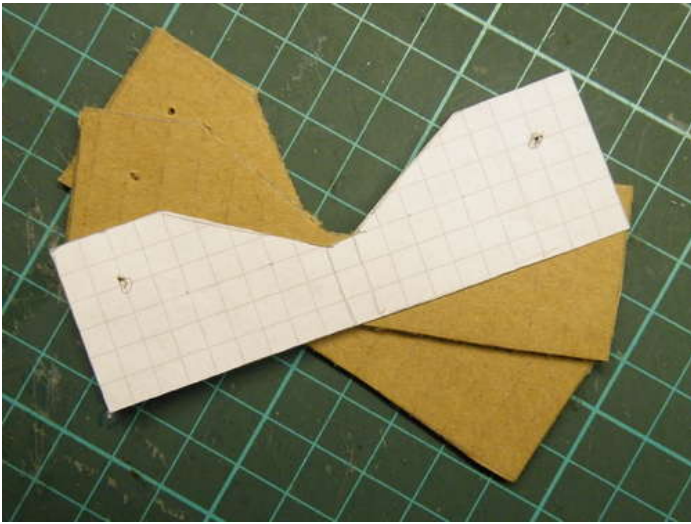

Image Notes

1. It stands, but is still headless.

step 6: Head.

The head was folded from a single piece of cardstock, following the template I have drawn and included in the images.

Score all the folds before folding it, and fold the side around first, making sure that the two letter-box-like holes line up.

Next, fold the top of the head over, loop the long narrow piece up inside the head, and thread it into the letter-box holes to hold the head together.

It is not fixed in place at all - it is balanced on top of the "neck".

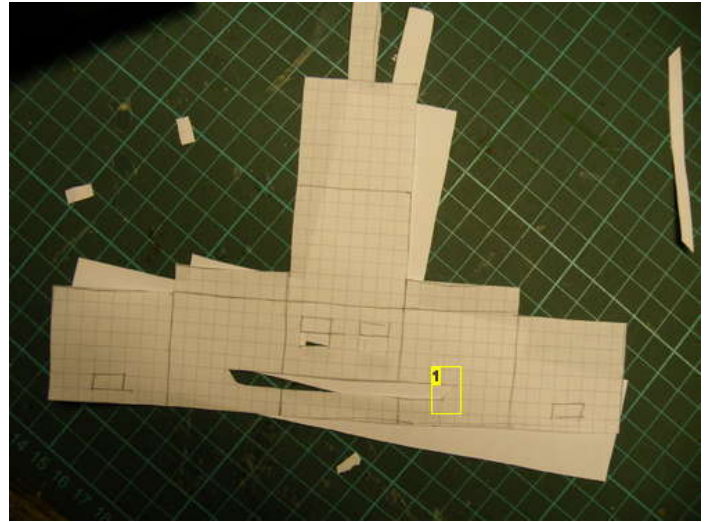
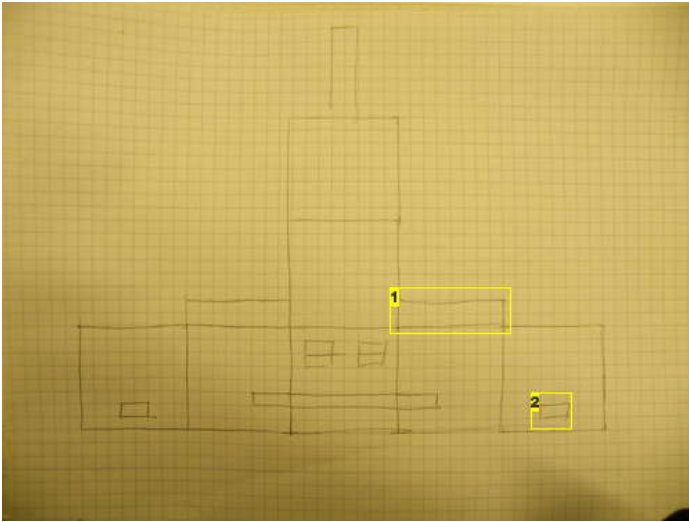
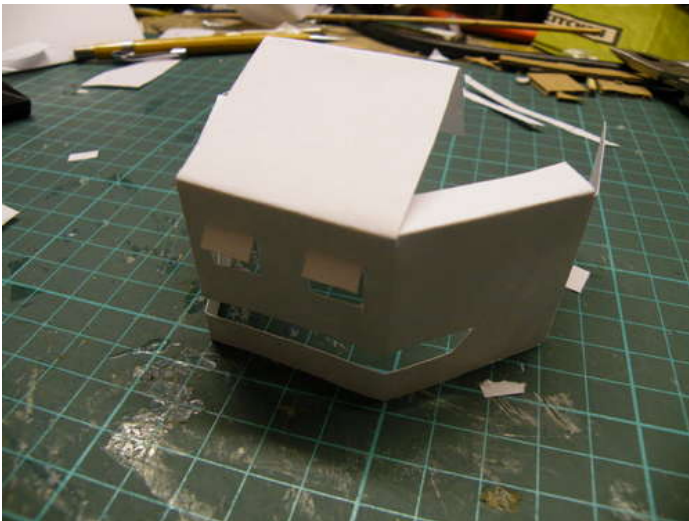

Image Notes

1. These flaps fold under the top of the head.
2. "Letter-box"

Image Notes

1. I drew the mouth square, but cut it at an angle to add some "life" to the expression.



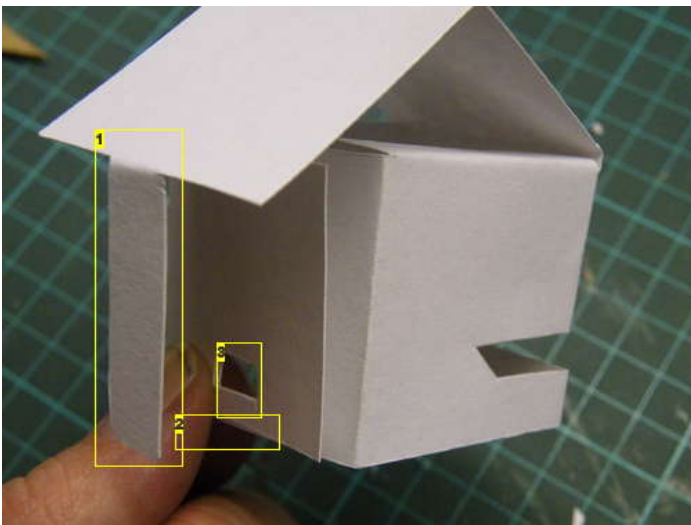

Image Notes

1. This long bit...
2. ...goes under this edge...
3. ...and back through these holes.

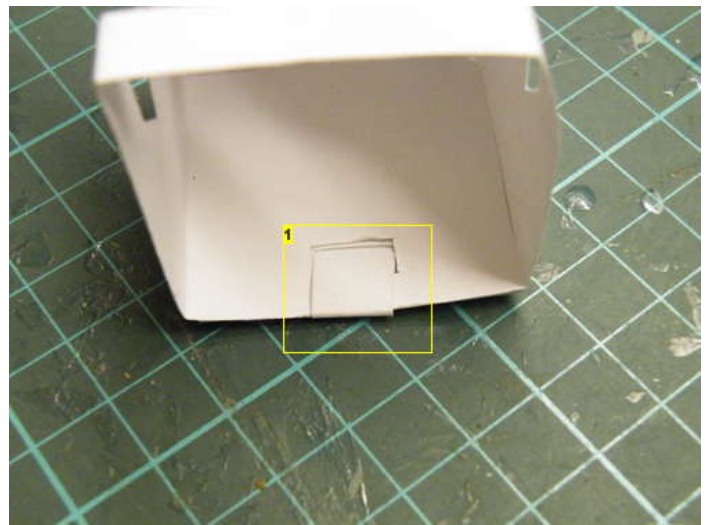

Image Notes

1. The long tab, finished threading.

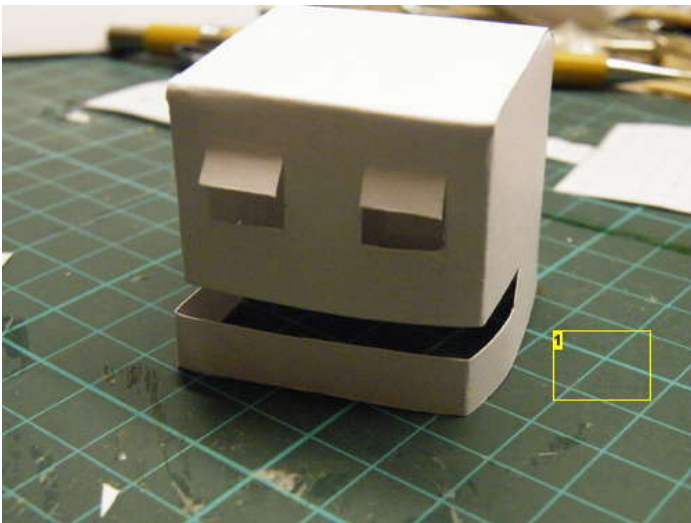

Image Notes

1. The expression appeals to me...

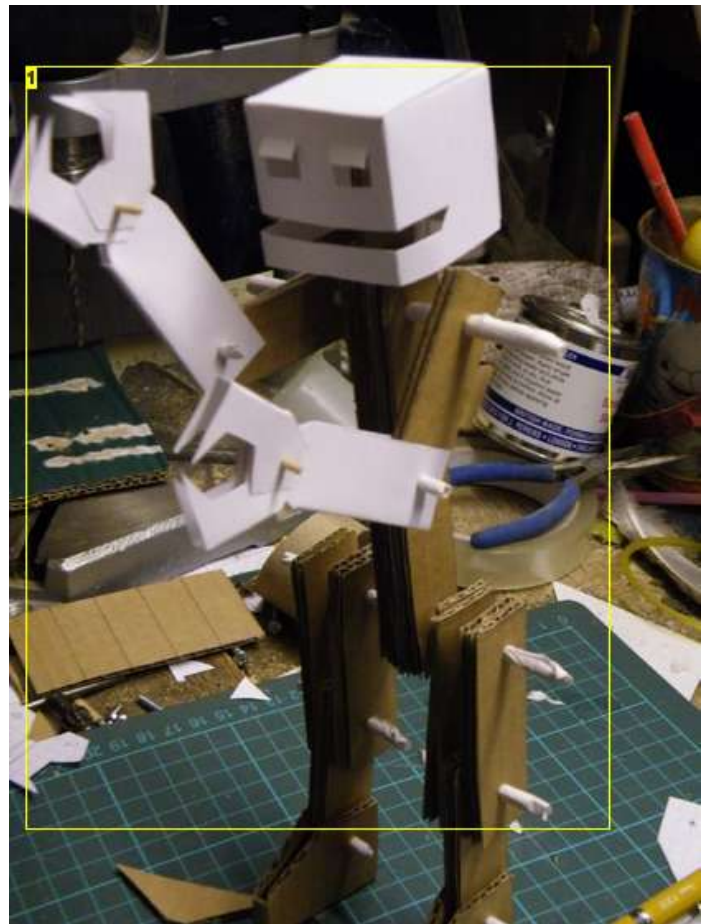

Image Notes

1. Done!

step 7: Finishing.

The robot is effectively finished, apart from a little trimming - I snipped off the ends of the various rolls of paper, to make the joints look tidier.

A change of background, and it's time to pose for the camera...

- The **Glueless Robot** has been a half-formed idea for some time, but the whole didn't gel properly until the last day of the contest. If I'd had more time, I would have either sourced some cardstock that was closer in colour to the corrugated card, or painted the whole thing after building. Maybe I'll paint him in the future. Maybe I won't.

So, not so much a kit as a set of guidelines - what will you make? Post photos, let us see.

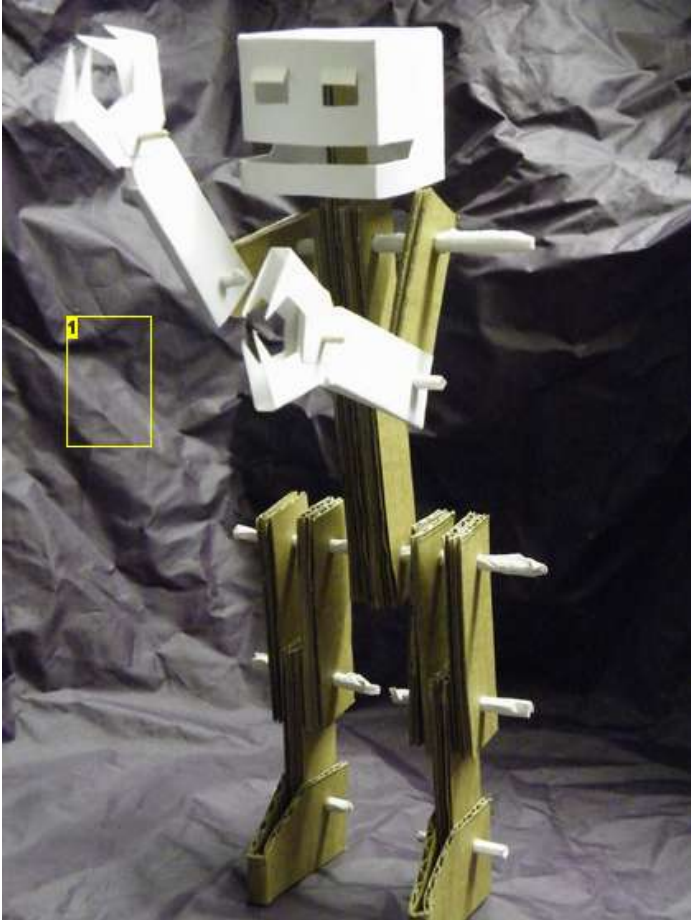

Image Notes
1. Grrrr!

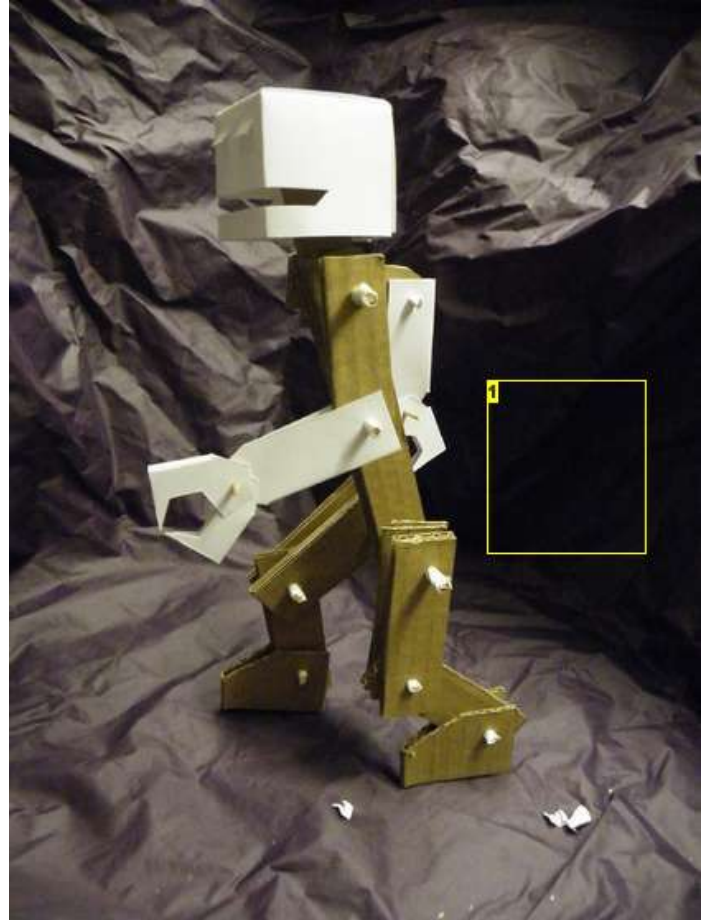
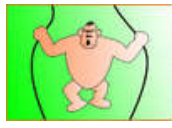

Image Notes
1. Ohhh, I'm a big stompy robot!

Related Instructables



Cardpunk Goggles by Kiteman



Climbing Cardboard Gorilla by Kiteman



How To Enter the Gorilla Glue Cardboard Contest by Contest Robot



Building Daddy's Shed. by Kiteman



Cardboard 'Jacob's Ladder' - Tumbling Gorillas by Kryptonite



Use Cardboard To Make A Billfold or Wallet! by Creativeman



Easy Cardboard Wallet by reutsap



Playing card usb case by Jeremia was a bullfrog

