

TITLE CONNECT FOUR			
SIZE A		DRAWN BY SUNY OSWEGO	REV
SCALE 1 / 2	MARCH 2, 2022	SHEET 1 OF 16	

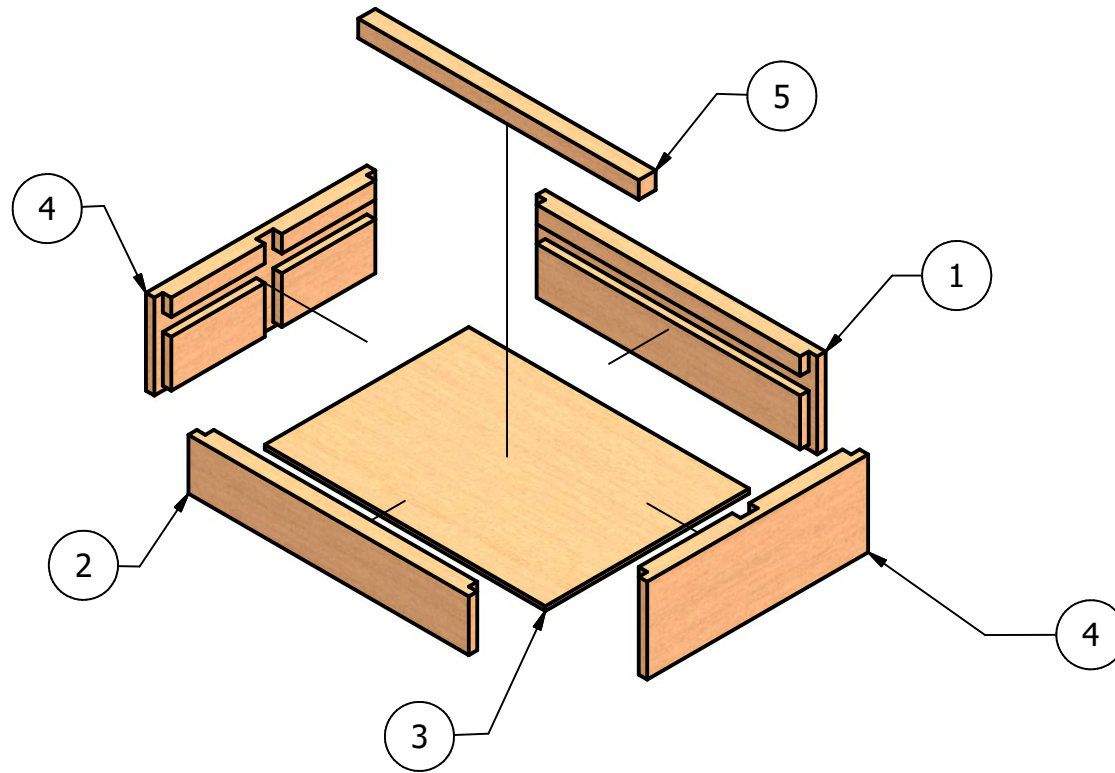

PARTS LIST			
ITEM	QTY	PART NUMBER	DESCRIPTION
1	1	BACK	
2	1	FRONT	
3	1	BOTTOM	
4	2	SIDE	
5	1	VERTICAL SPACER	



TITLE
BASE EXPLODED VIEW

SIZE
A

DRAWN BY
SUNY OSWEGO

REV

SCALE
1 / 4

MARCH 2, 2022

SHEET 2 OF 16

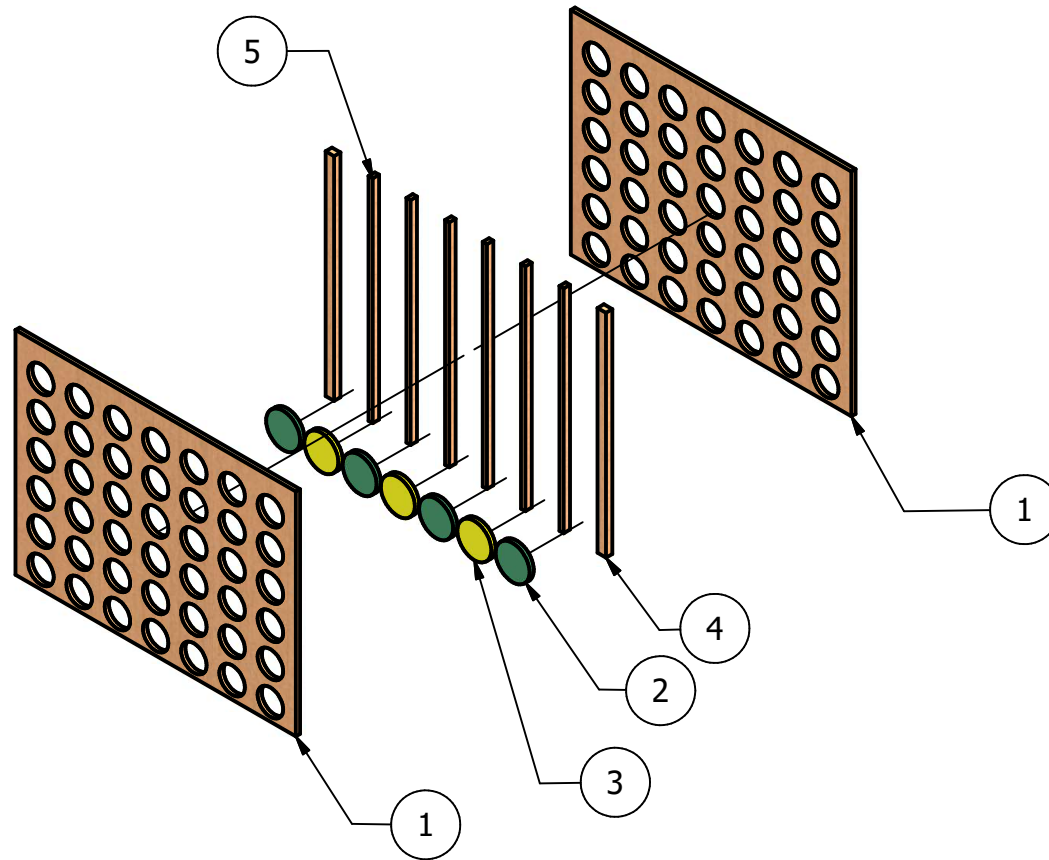

PARTS LIST			
ITEM	QTY	PART NUMBER	DESCRIPTION
1	2		GRID
2	4		GREEN CHECKER
3	3		YELLOW CHECKER
4	2		GRID SPACER
5	6		GRID EDGE

	TITLE		
	SIZE A	DRAWN BY SUNY OSWEGO	REV
	SCALE 1 / 4	MARCH 2, 2022	SHEET 3 OF 16

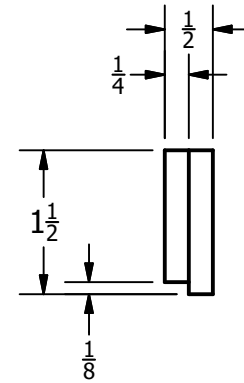
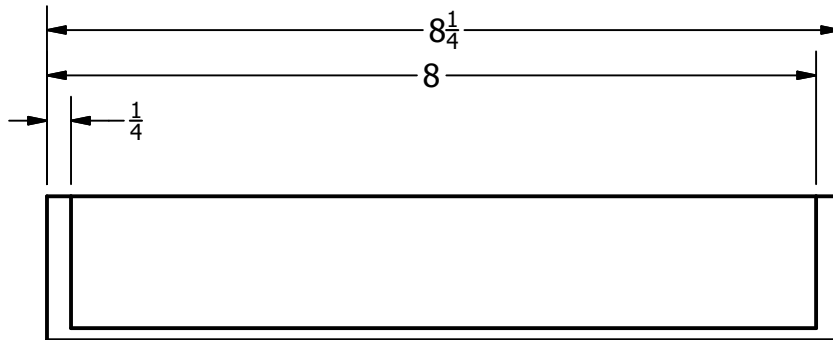
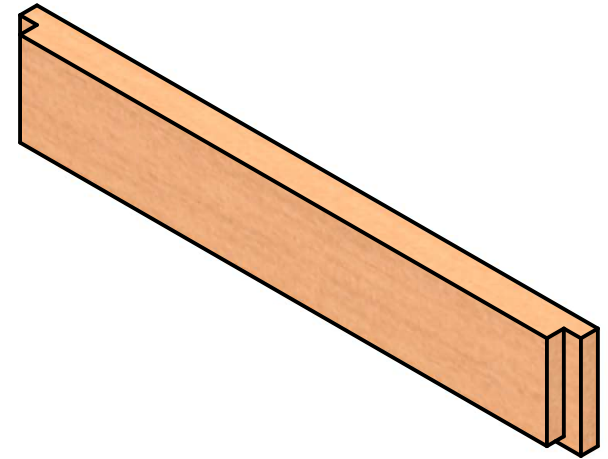
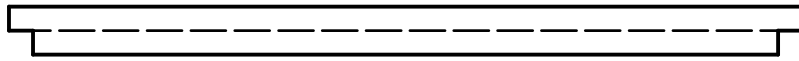

TITLE FRONT			
SIZE A		DRAWN BY SUNY OSWEGO	REV
SCALE 1 / 2	MARCH 2, 2022	SHEET 4 OF 16	

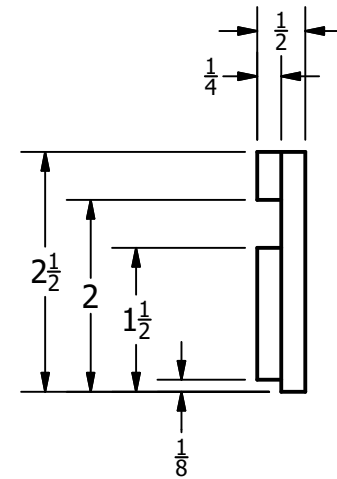
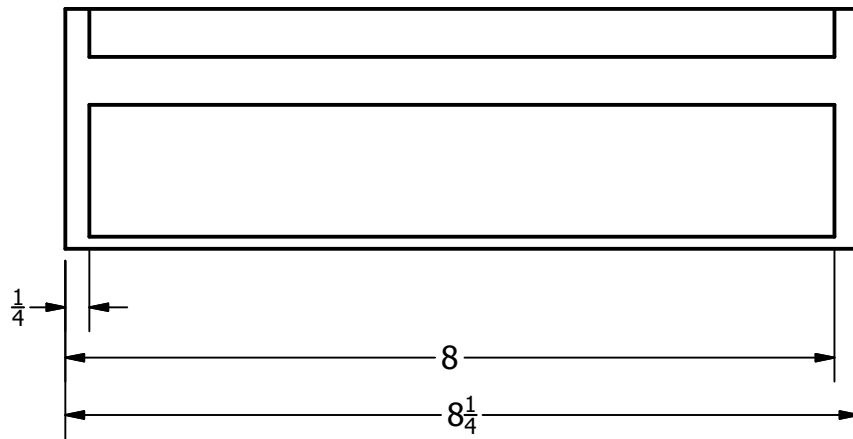
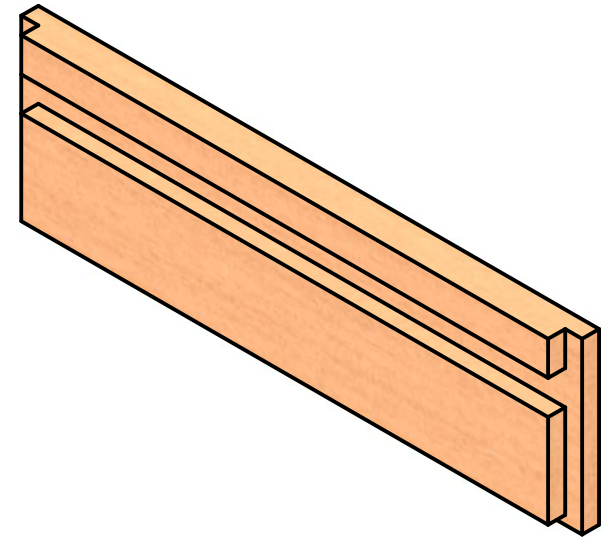
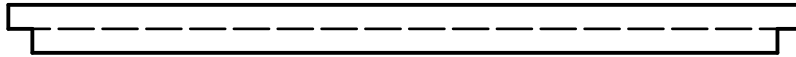

TITLE BACK			
SIZE A		DRAWN BY SUNY OSWEGO	REV
SCALE 1 / 2	MARCH 2, 2022	SHEET 5 OF 16	

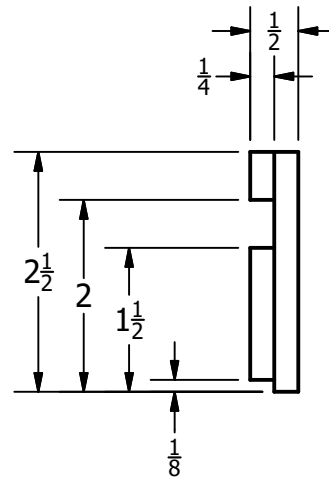
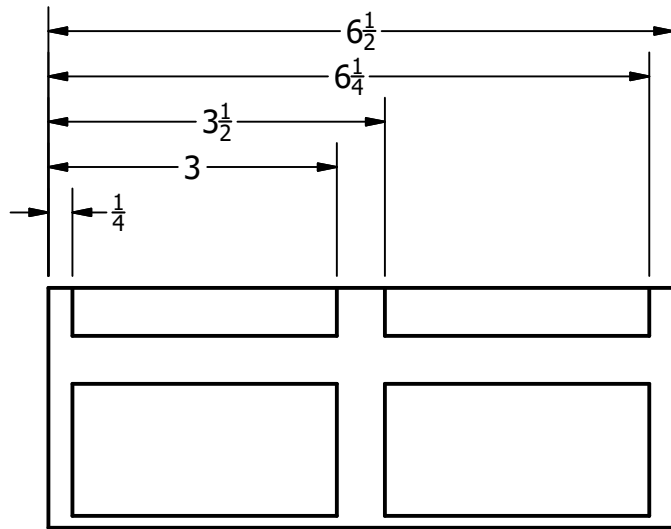
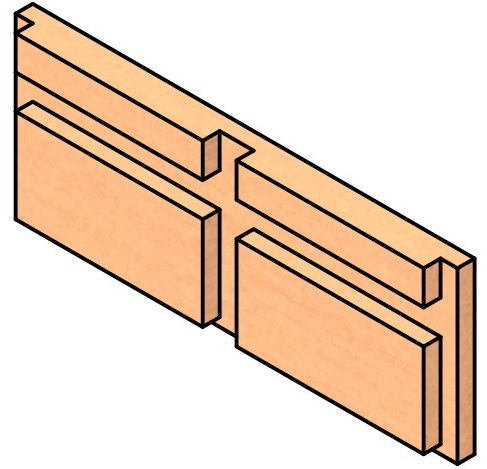
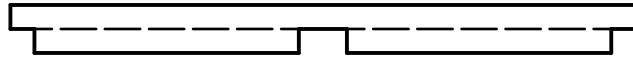

TITLE SIDE			
SIZE A		DRAWN BY SUNY OSWEGO	REV
SCALE 1 / 2	MARCH 2, 2022	SHEET 6 OF 16	

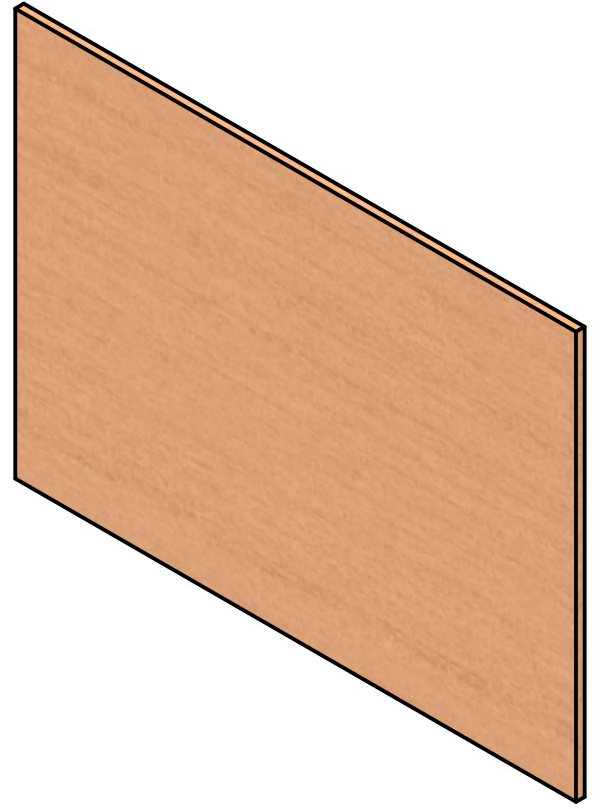
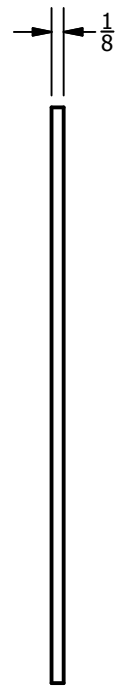
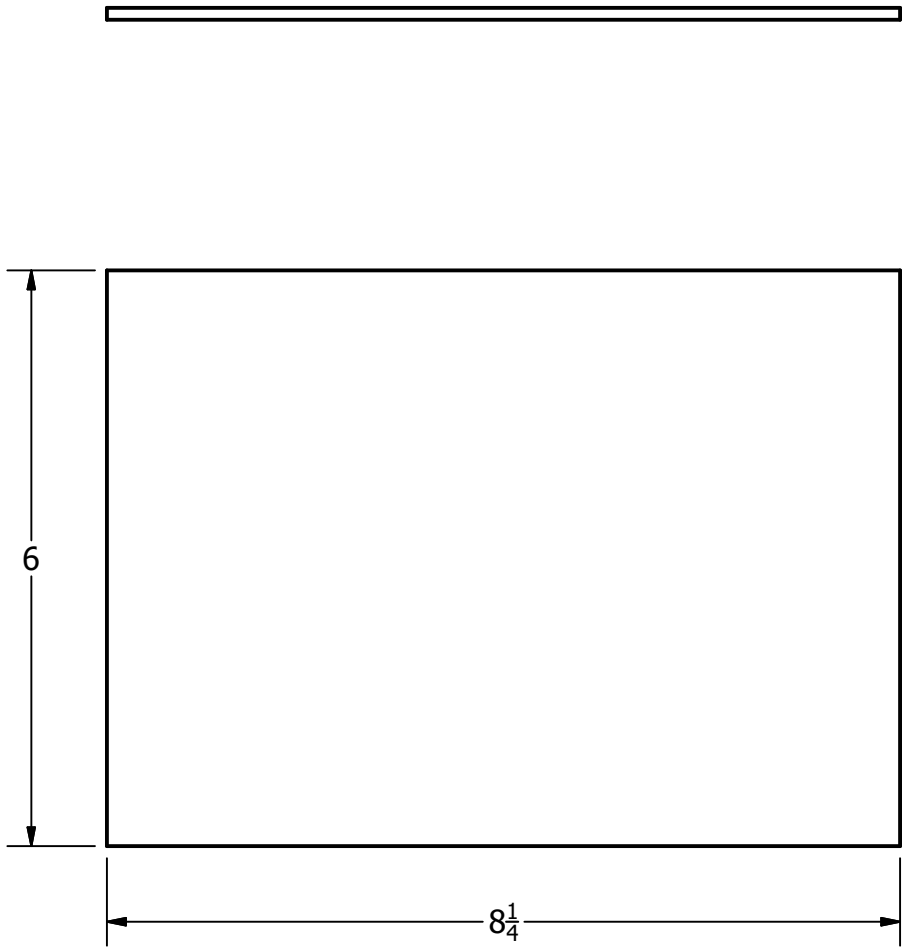

TITLE BOTTOM			
SIZE A		DRAWN BY SUNY OSWEGO	REV
SCALE 1 / 2	MARCH 2, 2022	SHEET 7 OF 16	

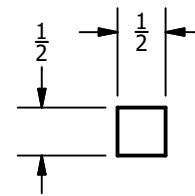
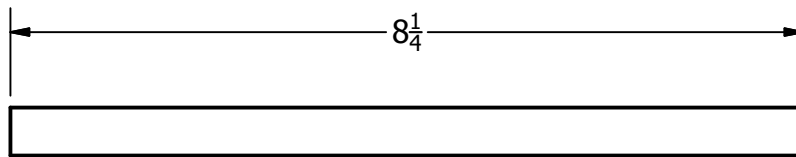
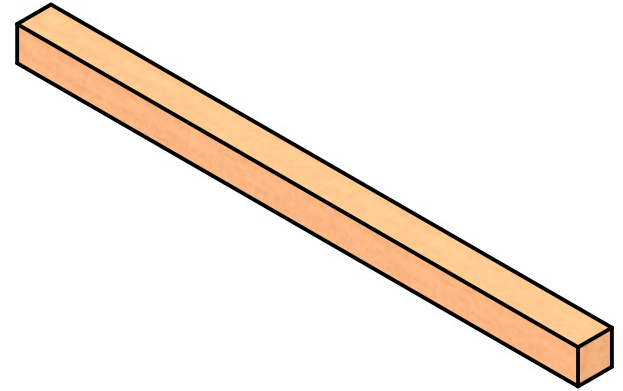

TITLE VERTICAL SPACER			
SIZE A		DRAWN BY SUNY OSWEGO	REV
SCALE 1 / 2	MARCH 2, 2022	SHEET 8 OF 16	

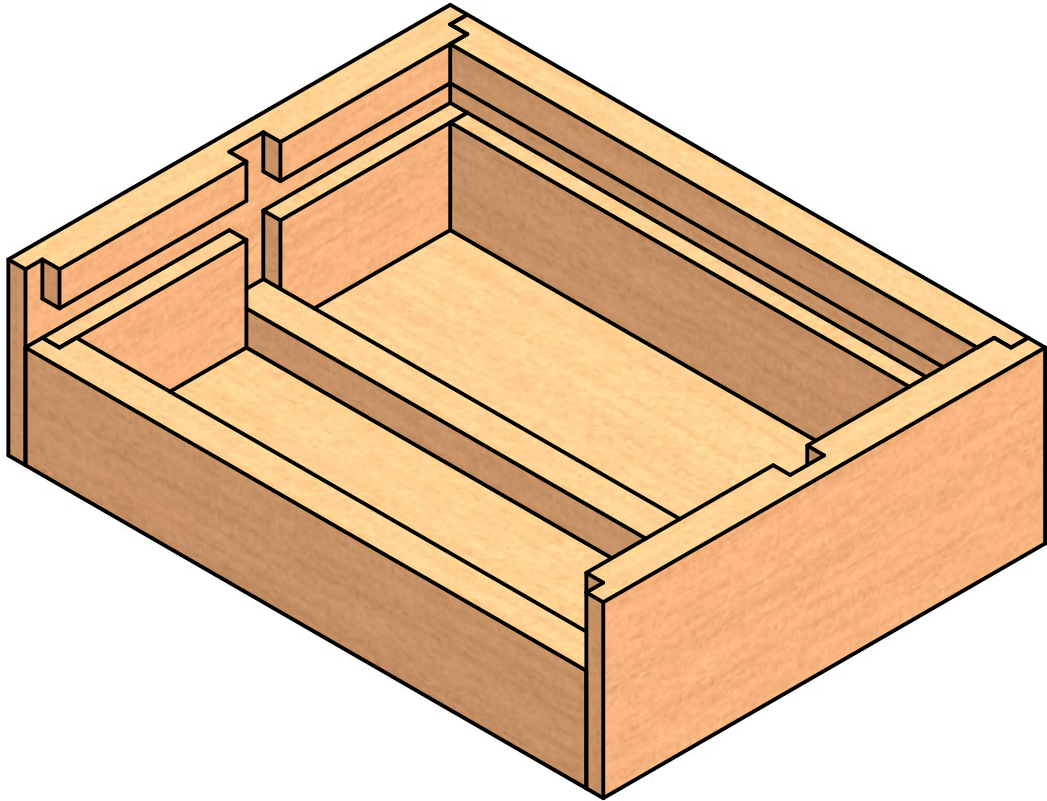

TITLE BASE ASSEMBLY			
SIZE A		DRAWN BY SUNY OSWEGO	REV
SCALE 1 / 2	MARCH 2, 2022	SHEET 9 OF 16	

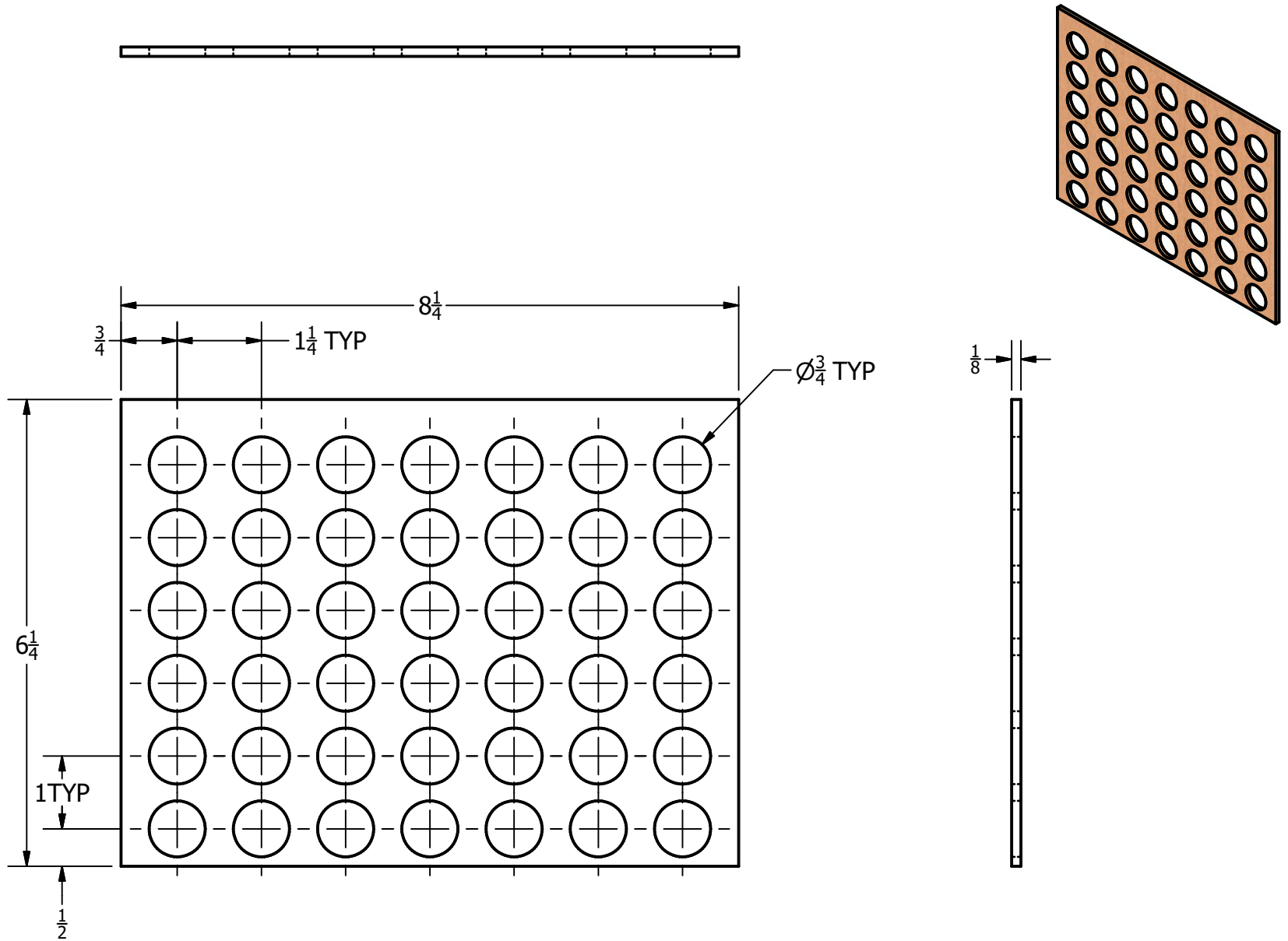

TITLE GRID			
SIZE A		DRAWN BY SUNY OSWEGO	REV
SCALE 1 / 2	MARCH 2, 2022	SHEET 10 OF 16	

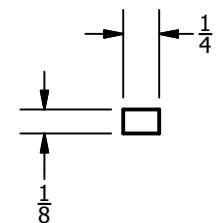
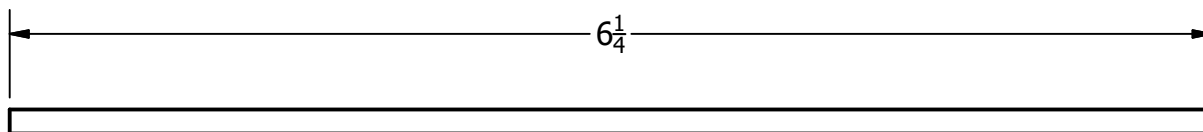

TITLE GRID SPACER			
SIZE A		DRAWN BY SUNY OSWEGO	REV
SCALE 1 : 1	MARCH 2, 2022	SHEET 11 OF 16	

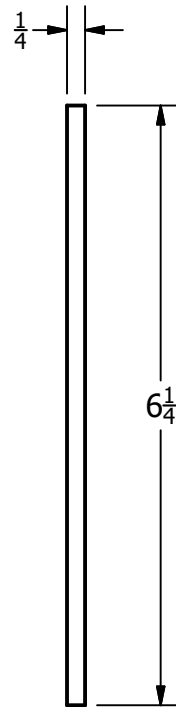
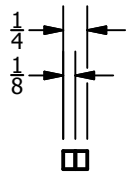

TITLE GRID EDGE			
SIZE A		DRAWN BY SUNY OSWEGO	REV
SCALE 1 / 2	MARCH 2, 2022	SHEET 12 OF 16	

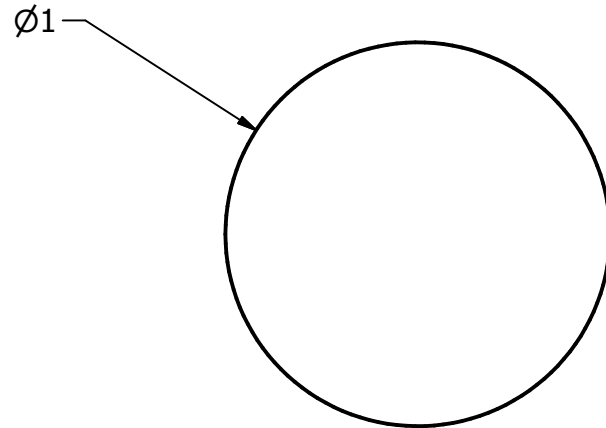
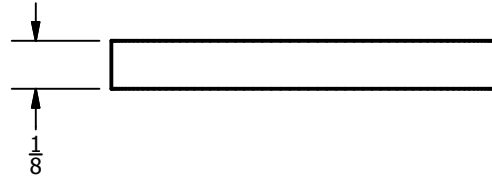
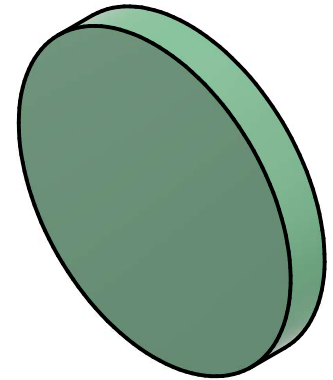

TITLE DARK CHECKER			
SIZE A		DRAWN BY SUNY OSWEGO	REV
SCALE 2 : 1	MARCH 2, 2022	SHEET 13 OF 16	

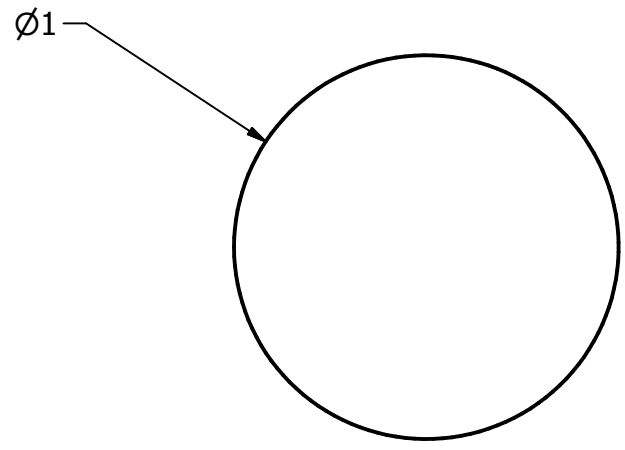
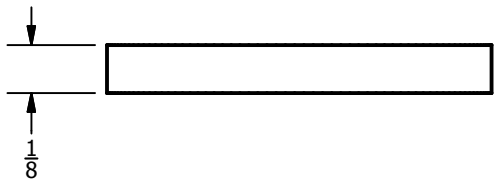
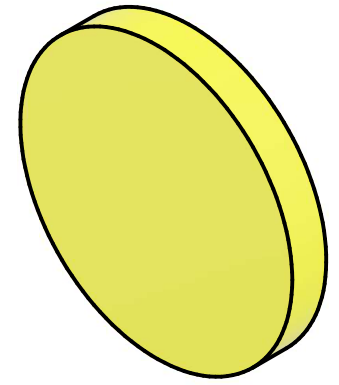

TITLE LIGHT CHECKER			
SIZE A		DRAWN BY SUNY OSWEGO	REV
SCALE 2 : 1	MARCH 2, 2022	SHEET 14 OF 16	

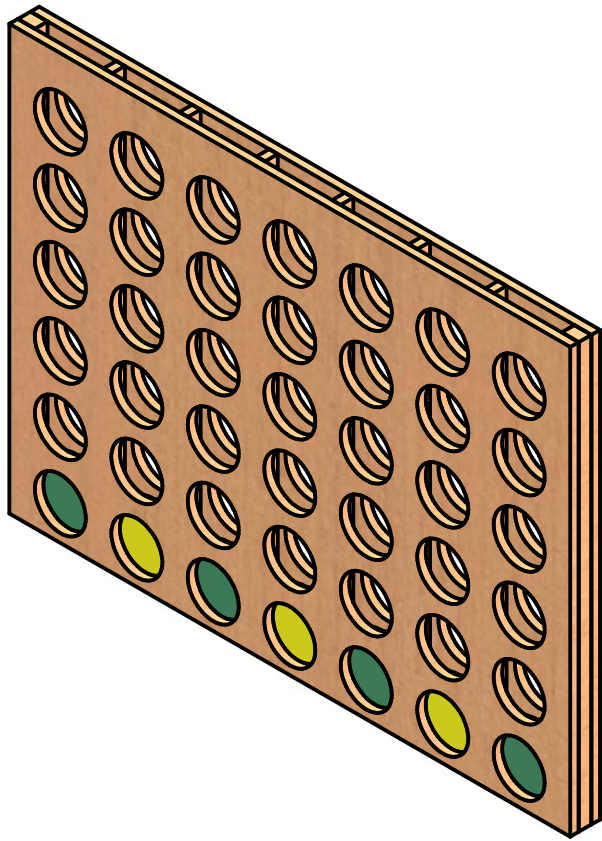

TITLE GRID ASSEMBLY			
SIZE A		DRAWN BY SUNY OSWEGO	REV
SCALE 1 / 2	MARCH 2, 2022	SHEET 15 OF 16	

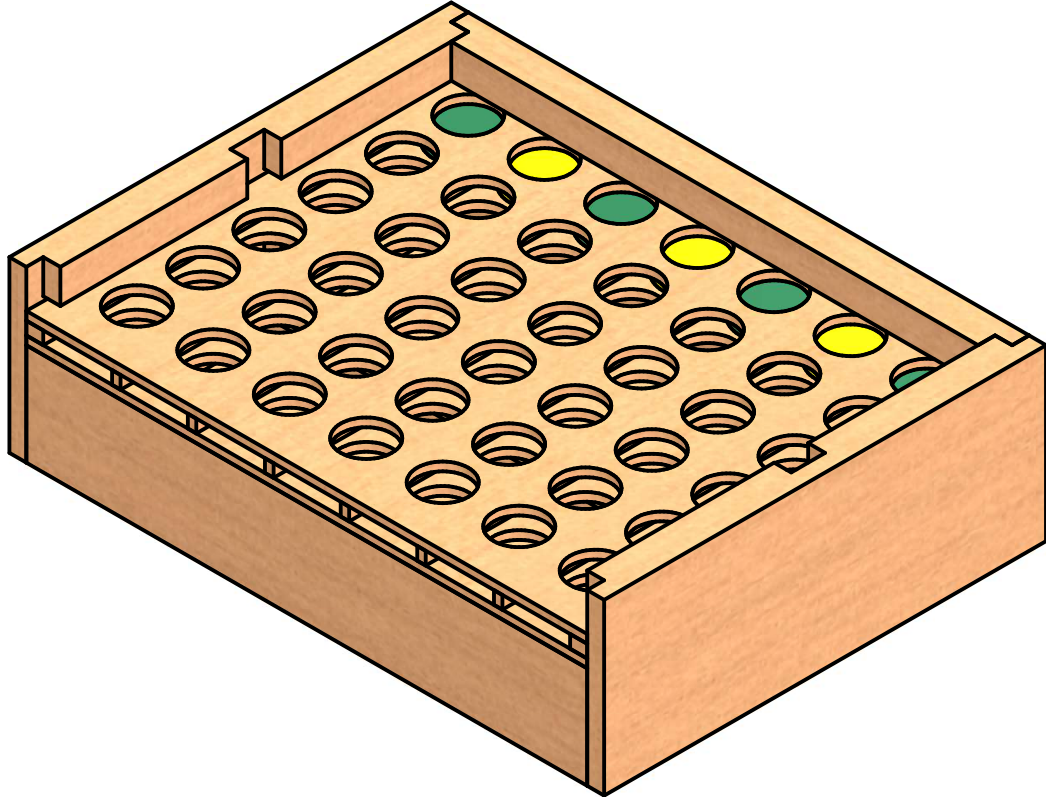

TITLE FOLDED ASSEMBLY			
SIZE A		DRAWN BY SUNY OSWEGO	REV
SCALE 1 / 2	MARCH 2, 2022	SHEET 16 OF 16	