

PLAY @ WORK CARDS!

Looking to shake up your workday a little. These cards will do the trick! Follow the printing and assembling instructions for the 26 cards below, and then you are on your way to a more playful day!

1. Print out your cards: In your printer settings, select "Print on both sides of paper." Select "Flip on short edge." Then, PRINT.
2. Cut out each "play @ work" card along the dotted lines (top and center)
3. Stack 'em up. Assemble them however you'd like.
4. Start playing at work and having fun!
5. Share your fun on Instagram! [#overworkedunderplayed](#)

BONUS FUN ON EACH PAGE!

Hang on to the strips of paper left over when you're done cutting out your cards. On each strip you will find a task or a game or a puzzle. Complete a task and earn the point value assigned to it. Keep track of your points and see how many you can score by the time you finish cutting out these cards!

To make it even more interesting, challenge a co-worker to print their own set and see who can score the most!

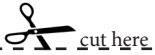

OVER
WORKED.
UNDER
PLAYED.

How to transform your work space and work culture for play.



Not sure about
how or where to
start introducing
play at work?

KEEP TRACK OF YOUR POINTS!

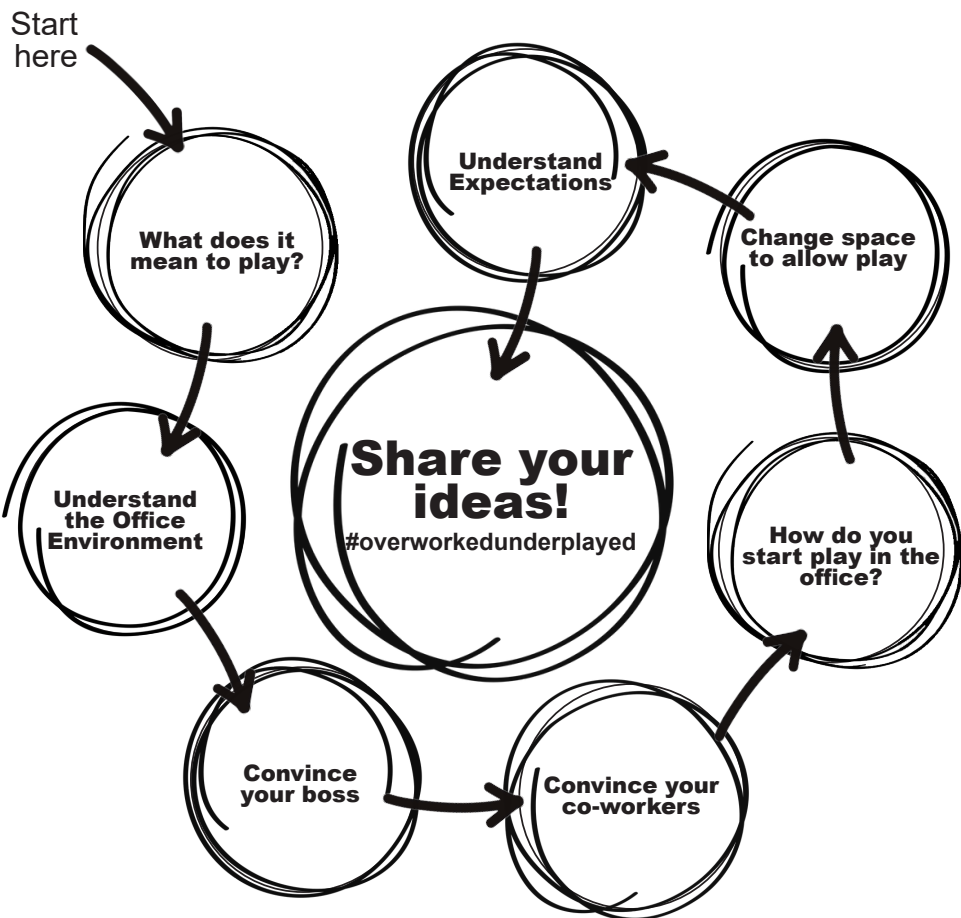
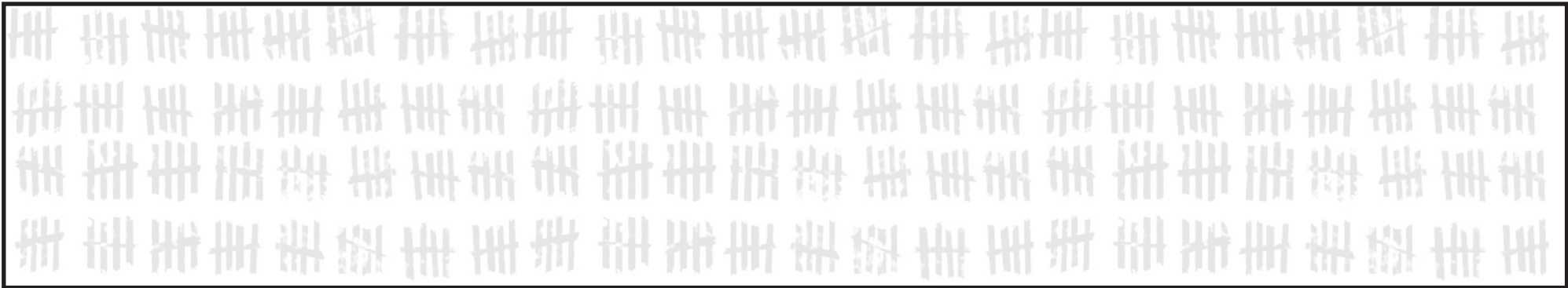

Introduction

Time is money. And thanks to this old adage, we are expected to be productive *all of the time*. In today's work culture, taking breaks is now seen as a weakness and typically frowned upon by superiors.

But, we need breaks. This doesn't just mean a coffee break. While most would argue that caffeine is an important way to survive the workday, we also need real breaks. Breaks that give our brains a chance to relax and switch gears for a moment. Sometimes, we just need to play.

Use these cards to **PLAY @ WORK!**

Color. Doodle. Scratch out. Add in. Pin up. Make them your own. Let these cards be a part of your new work style. Help to transform the stuffy, old, traditional work culture into a place where fun and productivity go hand in hand.

SHARE your fun!

Show me what you've got! Snap a pic of your drawings, ideas and games, experiences as you play your way through these cards. Share them on Instagram using **#overworkedunderplayed**. Then, check out how others are finding ways to play at work, too!

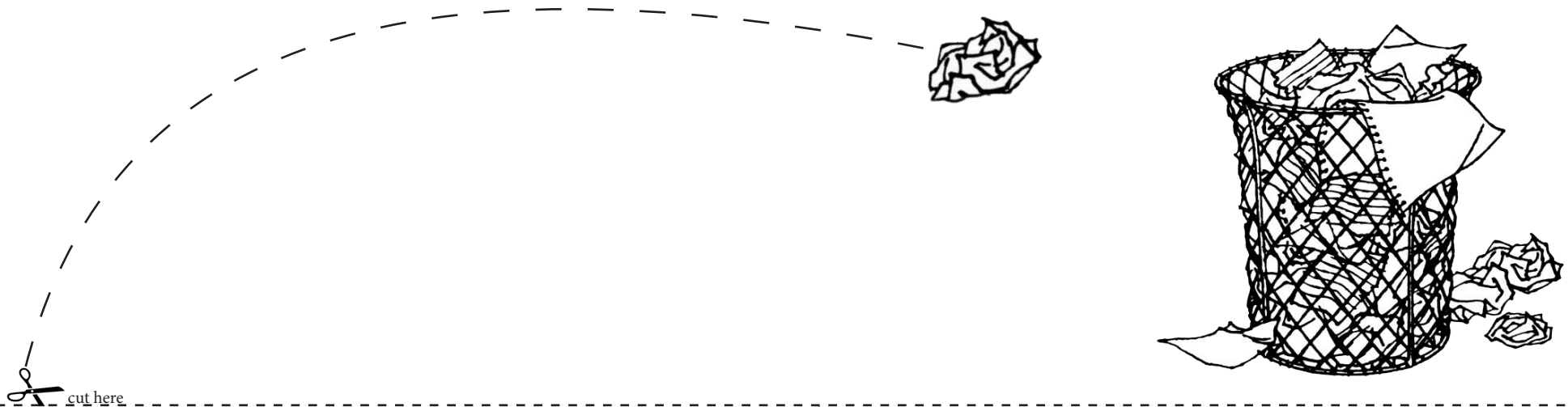

Let's talk about play, baby

The words “work” and “play” are not typically two that you would put together. If you’re working, then you are not playing. And if you’re playing, then you are defiantly not working. But, why is that?

This is called the “play differential”. A clear separation of play and work. It most likely stems from the stigma around the word “play”. Playing is what we think of children doing. Or playing is wasting time. But, that’s not true. For adults, playing can mean a variety of things. Really, when you get down to it, playing just means TAKE A BREAK! Let your brain think about something else for a little while and do something other than work.

Play is what you make it.

In order to get the most benefits out of play, it really needs to be incorporated into our everyday lives. That means that play is not reserved just for vacation. We need to find ways to play, each and every day. But play might look different for everyone.

A way to determine what type of play is best for you is to take a trip down memory lane. You need to establish your “play history”. To do this, envision your favorite childhood memory in which you were playing. What were you doing? Doing something along the same lines as what you played as a child should give you the most fulfillment from your play.

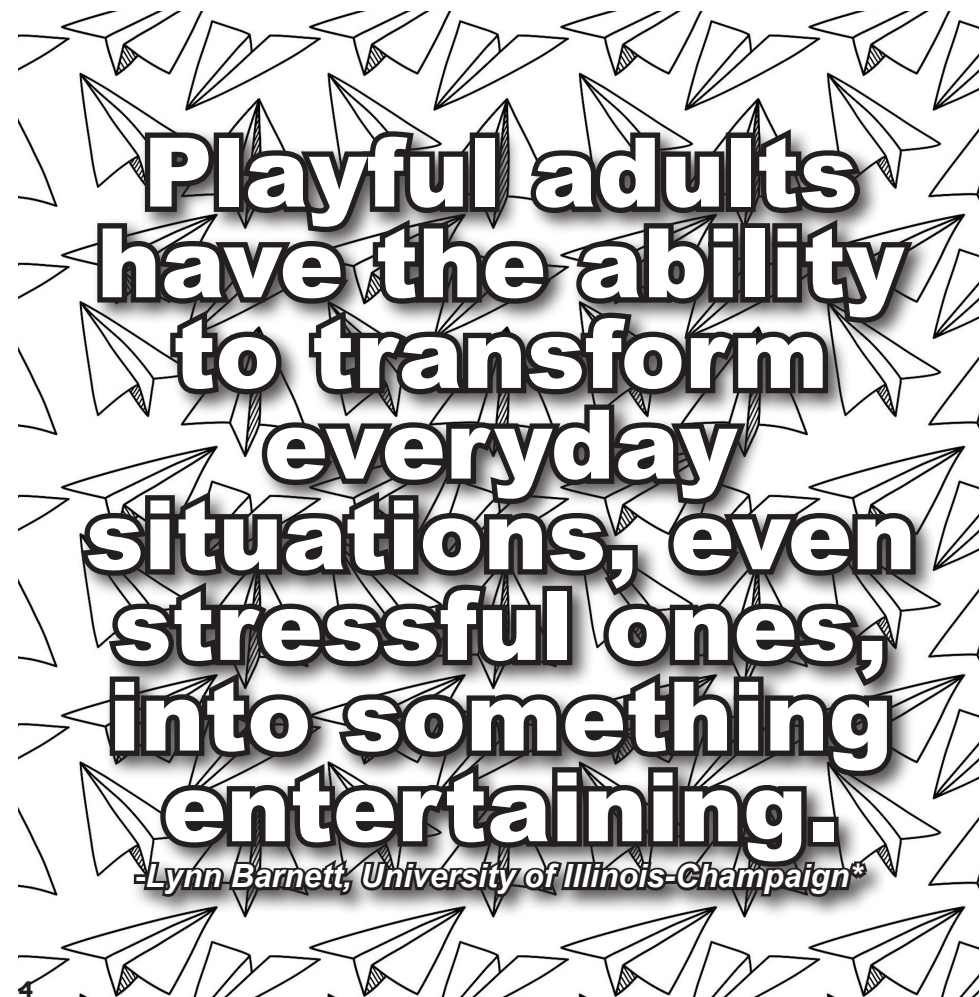

**Playful adults
have the ability
to transform
everyday
situations, even
stressful ones,
into something
entertaining.**

*-Lynn Barnett, University of Illinois-Champaign**

Crumple up this strip and try to make a (waste)basket.

+1 point

If you make it.

+2 points

If you make it into one of your co-worker's (waste)basket.

+3 points



cut here

Play Tip: FIND OUT WHAT TYPE OF PLAYFUL ADULT YOU ARE!

In order to get the most benefits out of play, it really needs to be incorporated into our everyday lives. In order to do so, you need to know figure out which category of playful adults you fall into.

Studies have shown that most adults fit into at least one of four playful categories:*

- Lively & Social:** “those who outwardly enjoying fooling around with friends, colleagues, relatives and acquaintances”
- Thoughtful:** “those who play with thoughts and ideas”
- Lighthearted & Uninhibited:** “those who are generally lighthearted and not preoccupied by future consequences of their behavior”
- Whimsical:** “those exhibiting interest in strange and unusual things and are amused by small, everyday observations”

Which one are you? (select all that apply)

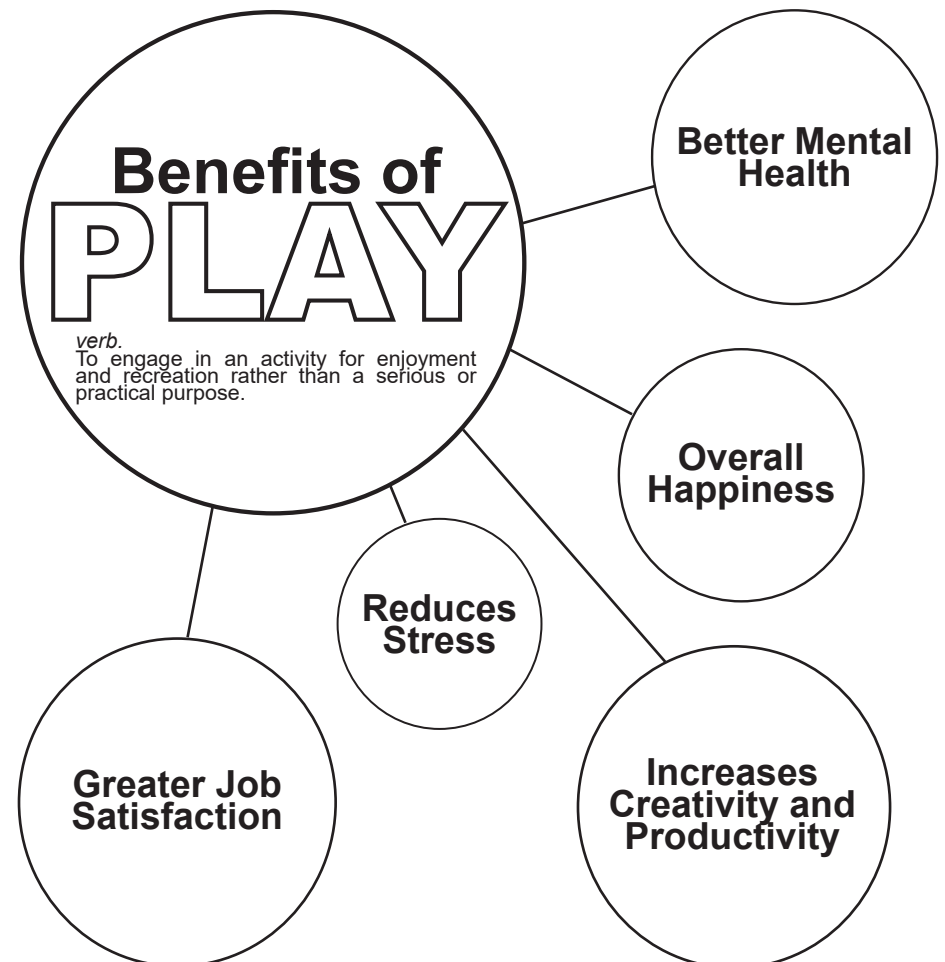

*Source: Wallace, Jennifer. *Why it's good for grown-ups to play.* The Washington Post. May 20, 2017. (www.washingtonpost.com/national/health-science/why-its-good-for-grown-ups-to-go-play/2017/05/19/99810292-fd1f-11e6-8ebe-6e0dbe4f2bca_story.html?noredirect=on&utm_term=.81f24337fd0a)

FOLD THE PENGUIN

1 point

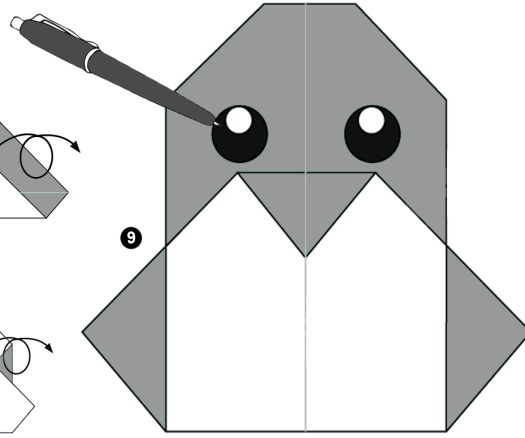
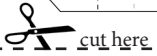
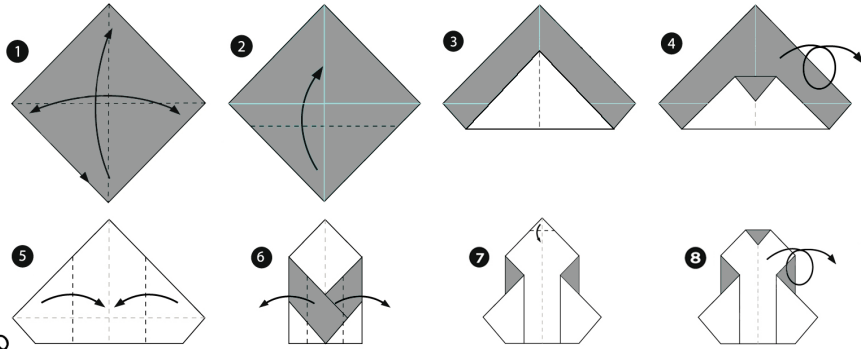

Use this square to make your penguin.

First, color it in!
+1 point!

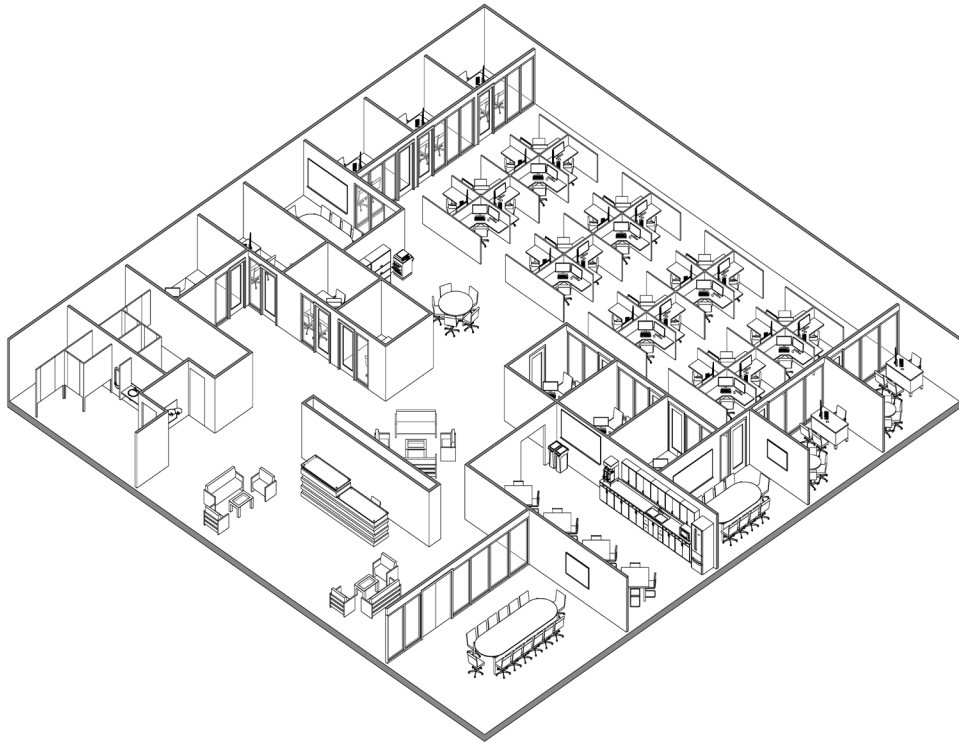

5

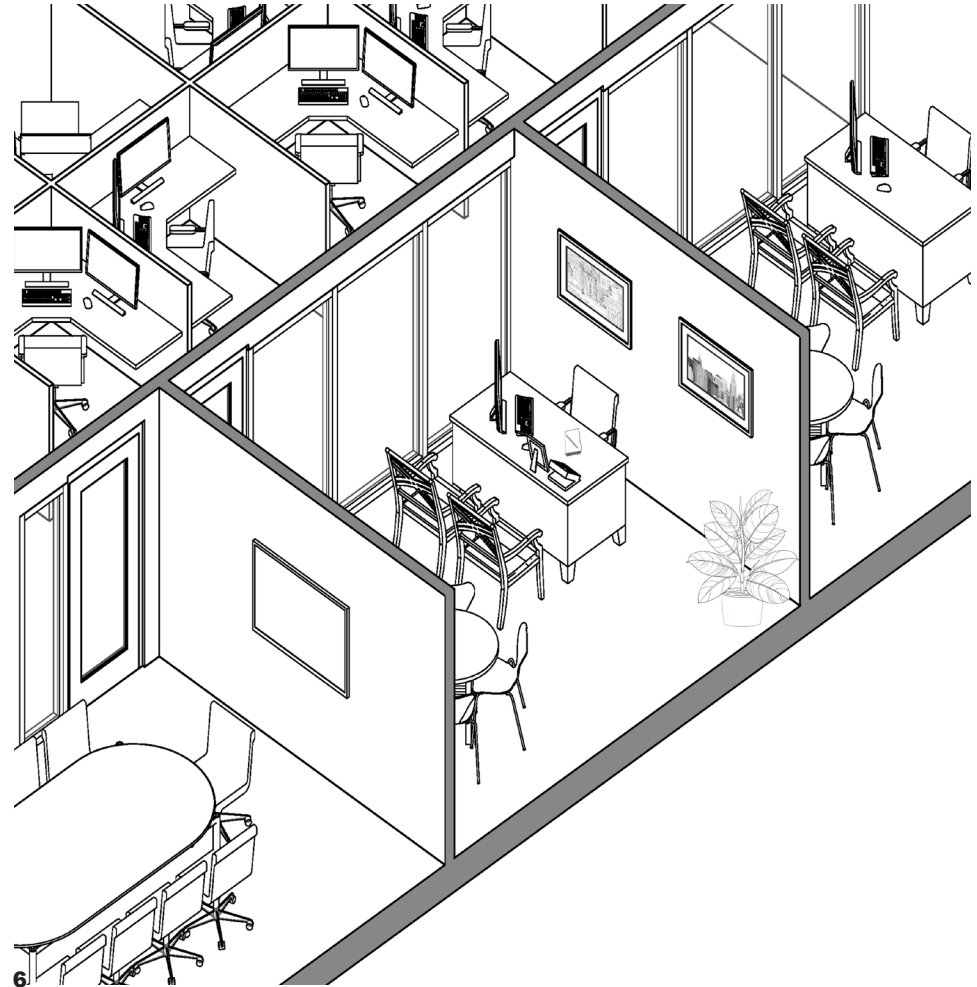

6

Did you make a penguin?

+1 point

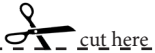

cut here

What does this have to do with play?

The Manager's Office

In most offices, the managers' offices are conveniently located on the perimeter, surrounding the cubicle space. This open office plan was designed with efficiency and productivity in mind. Managers always have the ability to see exactly what their employees are up to. After all, they are sitting only feet away. And, modern offices have taken it one step further with floor to ceiling glass for total transparency.

Nothing sets up a playful atmosphere like constant supervision.

This is your office

I know what you're thinking. "No, it's not! That looks nothing like my office." And, you're mostly right. But, take a closer look.

Disregard the size of the office or how many employees it holds. Look at the spaces and how they are arranged. I bet your office has pretty similar spaces. They may not be organized exactly like this, but I'm sure it's not too far off.

So, how did I know that? Because, all offices are basically the same. Around the middle of the 20th century, we apparently had totally figured out what an office looked like and we haven't bothered to do much with it since.

Convince a co-worker to play tic tac toe with you.

+1 point

For every game you win.

+1 point



cut here

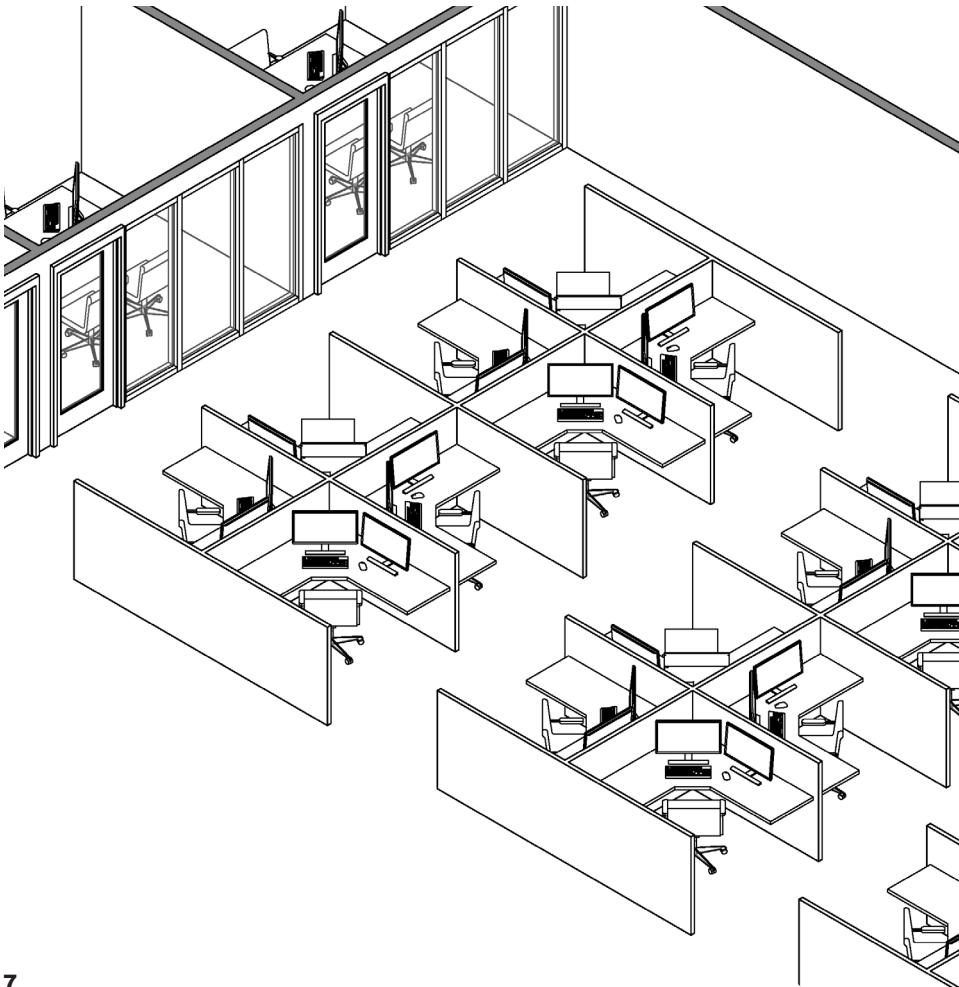

Get rid of the bosses!

What if we lived in a world where there were no bosses or managers? Every employee is now an equal. What would an office look like?

Try it out!

Turn this card over and take a stab at how an office might be laid out if we no longer had bosses or managers. Don't worry. There is no wrong answer! Think about what spaces you would keep? What don't you need anymore? How would people organize themselves?

How do you think this new layout impacts the office culture? Would it encourage more play?

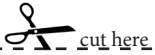
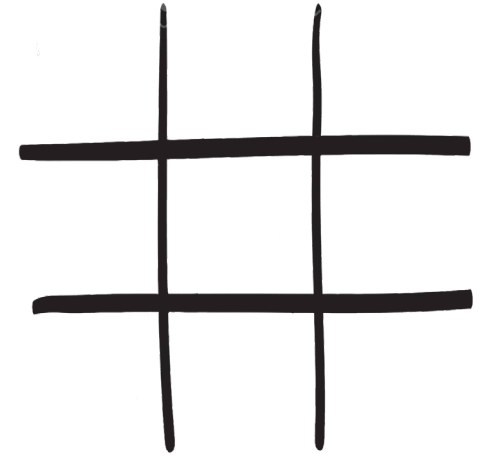
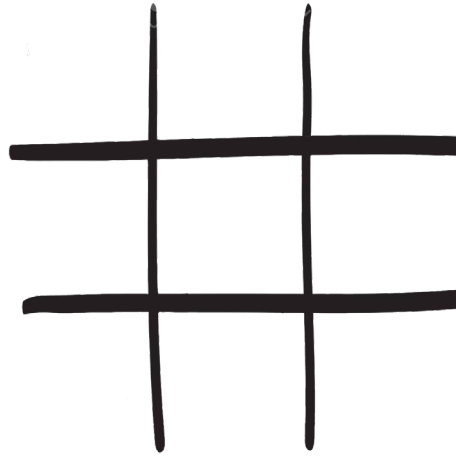
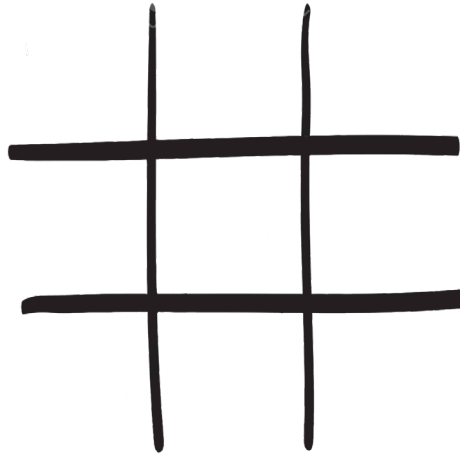

SHOW ME WHAT YOU'VE GOT!

What does this have to do with play?

The Cubicle

As it's been mentioned before, the open office plan came out of the need for efficiency and increased productivity. This established offices with seas of cubicles, organized neatly in rows, in the middle of all the offices.

Not only are your bosses just feet away, but your co-workers are, too. Aware of your every move. You don't want to be seen as being less productive than the person next to you (or across from you, or behind you). These close quarters makes doing something out of the ordinary very apparent. They are literally set up to keep you from playing.

No one wants to be the _____ one.

(How would you describe someone who plays at work? Lazy? Obnoxious? Weird? Fill in the blank with your own adjective.)

Make a paper airplane.

+1 point

Fly it across the room.

+2 points

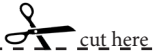

Get rid of the cubicles!

WHAT?! An office without cubicles? Is that even possible?

If you came into work tomorrow and all the cubicles were gone and no one had private offices, what would you make your new workspace look like?

Turn this over and show me!

How do you think this new layout impacts the office culture? Would it encourage more play?



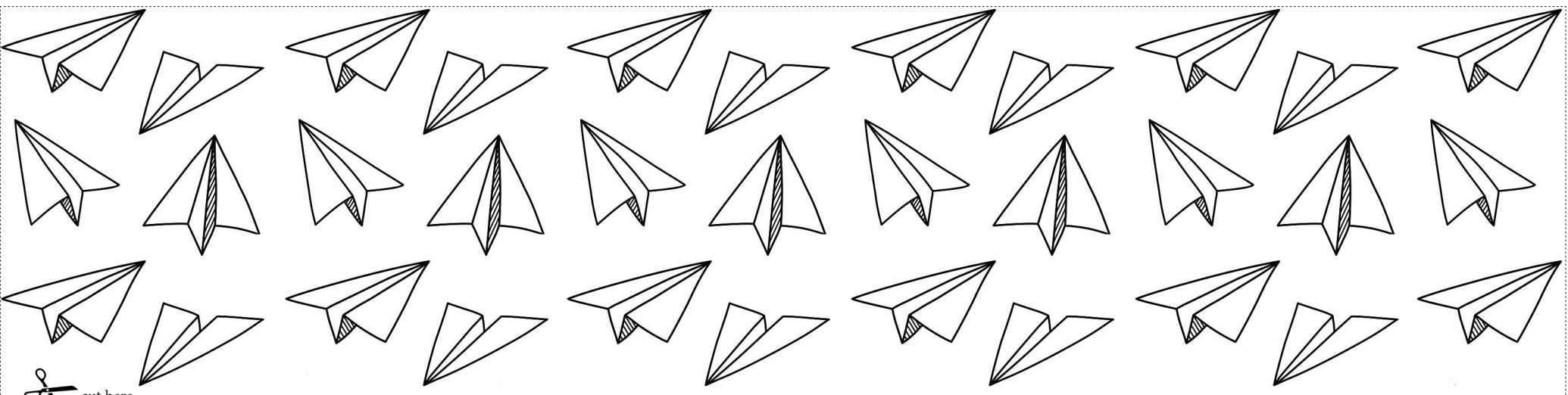

Play Tip: BE AN INSTIGATOR!

Play now. Ask for forgiveness later.

Playing at work might feel like breaking the rules at first. It is going to take a few people to take the chance, break the stigma and play, in order to show everyone how fun and beneficial it can be.

SHOW ME WHAT YOU'VE GOT!

A large grid of graph paper for writing notes or drawing.

Easy 1 point

	1						4
					3	5	
	2		9	3	1		6
7	8			1		4	
9			3	6	7		8
	3		5			2	9
4		9	1	5			3
	5	8					
1							8

Medium 2 points

		2	5	6			
	1			2		3	7
		4			3	5	1
			6			7	4
	2						3
5		6			4		
9		8	3			1	
	6	1		9			5
				4	6	9	

Hard 3 points

8			7			3	9
				9	1		8
	9	1		3			
	8					9	2
4							8
1	2	9					5
				7		5	6
	1		3	2			
	5	4			6		7



cut here

How to convince your boss.

It's probably no surprise that not every boss is going to jump right on board with the idea of playing at work. After all, the boss' job is to make sure everyone else is doing their job, right?! So, you are going to have to do a little bit of convincing.



The best approach for the really business oriented is to show them the cold hard facts. Prove to your boss that it really is worth it to play. Making them understand that play is beneficial to work ethic, productivity and collaboration, you might get their attention.

Also, knowing where your boss falls on the "cool enough to play" scale will help you to understand how to approach them. Your boss a little more cool than the average boss? They will take less convincing and may be open to hearing your ideas about play in the office. Your boss at the other end of the spectrum? Take it slow. They are not going to be easily persuaded. Be pragmatic!

Draw your boss where you think they fall on the scale!

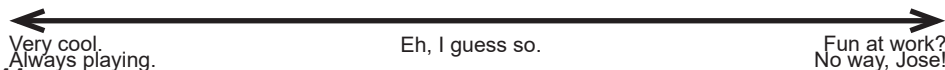

Need some help with the boss? Try cutting out this flyer and see if it can help persuade them?

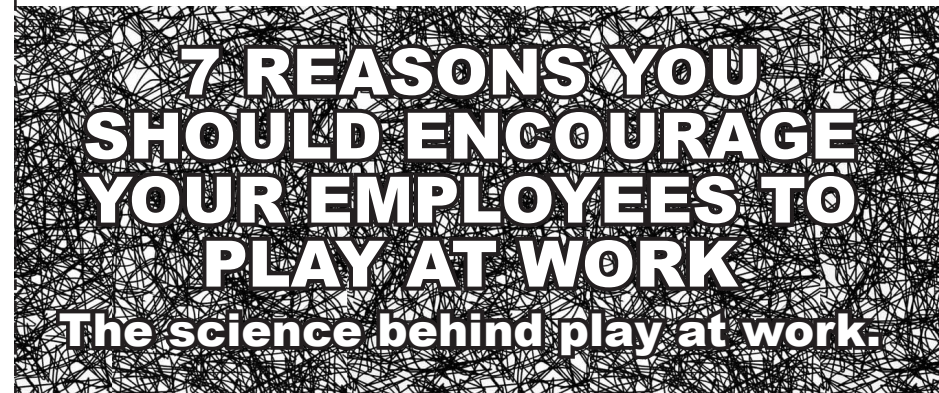

7 REASONS YOU SHOULD ENCOURAGE YOUR EMPLOYEES TO PLAY AT WORK.

The science behind play at work.

1.Reduces stress.

Is there a lot of tension in your workplace from stress? Playing releases endorphins, which make people happier and helps us better cope with stress. When an employee feels less stressed, their job satisfaction also increases. When job satisfaction increases, so does productivity. So, it's kind of a three-for-one deal on this one.

2.Strengthens bonds between co-workers.

Doing fun things together causes our body to release oxytocin. Oxytocin is a chemical that helps us feel more connected to other people. If you want your employees to have this connection with their co-workers, let them play. Playing will encourage more collaboration and mutual support in the workplace.

3. Boosts Creativity.

When we are playing, we are not as concerned about if are doing something right or wrong, we can just roll with it. If an employee is stuck on a problem at work, give them the opportunity for a break. Playing can open up their mind and spark their imagination, allowing them to see other possibilities that their stressed out, work driven mind wasn't.



cut here

Easy 1 point

1	4	6	5				7	
					4		8	
2		7			1	5		
8	5	1						
9								3
						4	9	8
		3	1			8		9
	7		8					
1				3	7	2	6	



Medium 2 points

4	8	5		1		6		
	3	2					8	
9			8					
5				2	8	1	4	
				6				
	1	6	7	9				5
					9			3
	5					9	2	
		3		5	7	6	4	

Hard 3 points

9			4		7	5		1
5	3					8		
					8	3	9	
		1			6			
6	3		1			2		7
		9				1		
	4	5	6					
		9					5	3
1	7	3	5					2

4. Improved Brain Function

Doing something that is new and challenging, such as a puzzle, makes our brains work a little bit harder, which helps it make new connections. These connections help combat some of the decline in memory that can come with age and the fatigue of performing the same task over and over again.

5. Better Sleep

Do you like your employees to stay awake at work? Moving around more, rather than the desk sitting, sedentary lifestyle we have developed, increases our bodies ability to reach the restorative deep sleep that we all need. Play can help encourage this movement.

6. More Confidence

Succeeding at something increases confidence. The more times you succeed at things the more confidence you will build. Allowing employees to partake in games gives them more opportunities to win, therefore increasing their confidence. If the whole team plays a game and succeeds together, the effect is even greater.

7. Setting more ambitious goals

Have some of your employees become complacent? Showing up, doing the bare minimum and then going home? Along with confidence, playing has been shown to encourage people to challenge themselves. To try to accomplish things they didn't previously think they could.

*“The opposite of play is not work - it’s depression.”
-Stuart Brown*

Still not convinced?

Try it out on yourself for a while. Challenge yourself to play and see if you can improve your work style.



Combat Strategies

Even with the facts, some bosses are going to take some more convincing. In the table below, find your boss' excuse of why you shouldn't play at work. Next to that excuse, try out the suggested response.

Boss' Excuse	Suggested Response
I'm not paying you to play, I'm paying you to work.	<i>Correct. You pay me to do my job and do it well. These breaks actually are helping me do my job even better than I was before. I'm really playing for you.</i>
Who's going to pick up your slack?	<i>I am! Playing will actually increase my productivity.</i>
People are going to just abuse the privilege and play all the time.	<i>Getting play ingrained into the work culture will make it feel less like a "privilege" and more like just another part of the day. It will be a part of their routine. A routine that still is predominantly work with a little play.</i>
Your boss' excuse...	Your response...
_____	_____
_____	_____
_____	_____
_____	_____

FOLD THE CAT

1 point

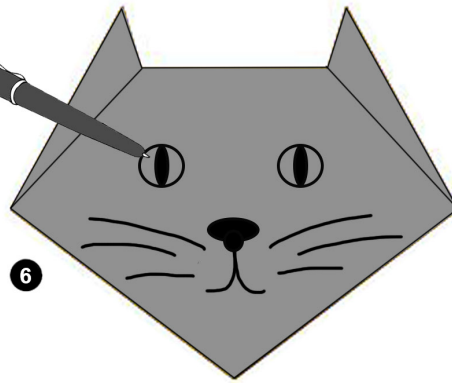
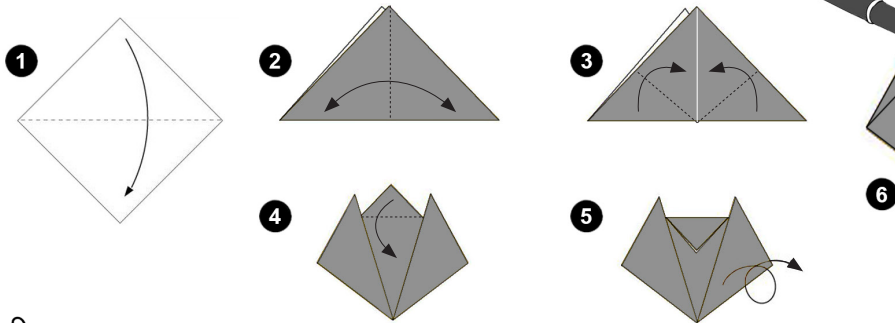

Use this square to make your cat. First, color it in! +1 point!

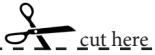

So, you're a cool boss.

Are you a manager that is already on board with the idea of play at work? Great! We're glad you're here.

Now, put your money where your mouth is.

Encourage all of your employees to play. Incorporate it into your everyday activities. Make it fun! Hold competitions and reward the winners with something that will make everyone else jealous. Make them want to win next time.

Use your power. You will have some people resist. Make some activities mandatory. You already understand how important play is to job satisfaction. Playing activities together with co-workers will strengthen social bonds and encourage better cooperation.

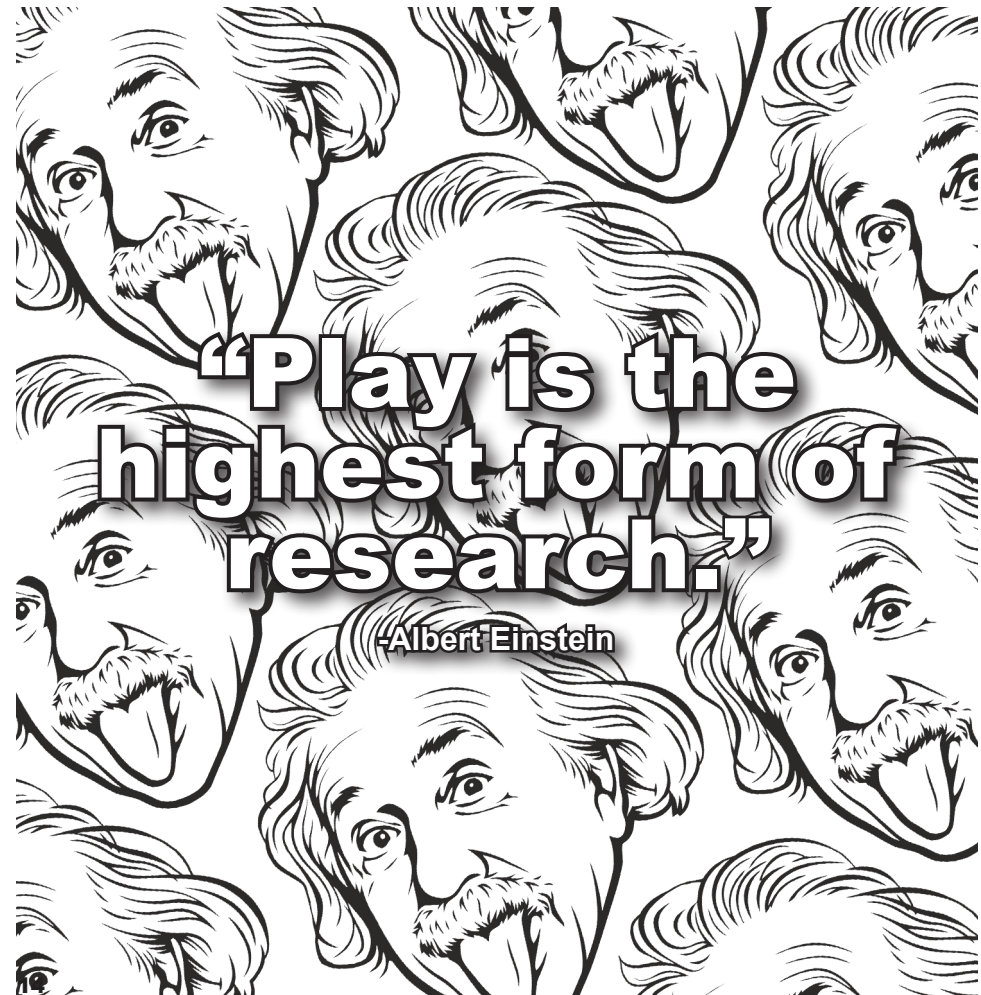

Did you make a cat yet?

+1 point

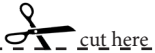

cut here

Play Tip: IT'S ALL RELATIVE!

Play doesn't have to mean disruptive, just different.

If truly letting loose and playing seems like too much of a risk at first, find a way to turn your normal work tasks into something a little more fun, like a game. Maybe, try to complete something on your to-do list as fast as you can and time yourself. Or challenge your co-workers to a "task duel", seeing who can finish their task first.

Making play more relative to your specific work or industry might help it be more widely accepted.

Do it with good intentions.



Don't put games out for your employees and tell them to take breaks through out the day to play, only to turn around and expect them to make up that time later. That would be counterproductive.

If you notice your employees abusing the privilege, educate them on the purpose. Make sure they understand that the benefits of play at work come when you are taking small breaks from work, not when you stop working all together.

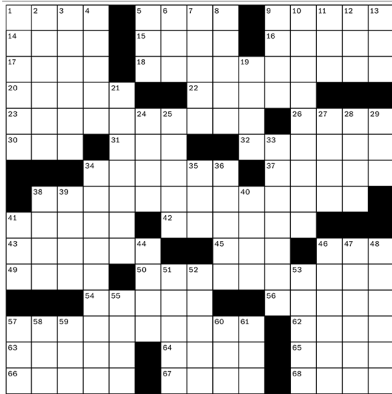

ACROSS

- 1 Overtime capital of the Mughal Empire
- 5 Pop star
- 9 Idea, at times
- 14 Apparently are
- 15 Bering Sea port
- 16 Center for Auto Safety co-founder
- 17 Part of the supreme Hindu trinity
- 18 Penny pincher
- 20 Trooper's outfit?
- 22 Moan and groan
- 23 Knot used to take up slack
- 26 Garden nuisance
- 30 Prof.'s helpers
- 31 Overtly
- 32 Fill with affection
- 34 Relax completely
- 37 Like lambs and rams
- 38 Amorphous sci-fi beings, and a hint to what's hidden in the four other longest answers
- 41 Pizzeria allure
- 42 Refreshers
- 43 Snapper?
- 45 Chinese restaurant general
- 46 The Mighty Mighty Bosstones music genre
- 49 One logging on
- 50 Prankster's weapon
- 54 Miniseries based on a Haley novel
- 56 Sucked (in)

DOWN

- 1 Give a hand
- 2 "Memoirs of a ___": Arthur Golden novel
- 3 Musical shows
- 4 Floor
- 5 Business mag
- 6 Self-critical cry
- 7 Seamaster watchmaker
- 8 Come to know
- 9 Clouseau's rank, briefly
- 10 Rock the boat
- 11 Periodontist's org.
- 12 Come down with
- 13 Long starter, once
- 19 Toll road
- 21 Passing muster
- 24 Footprint maker
- 25 Raise on a pole
- 27 Many an oil-rich ruler
- 28 Many ages
- 29 Death Row Records co-founder, familiarly
- 33 "You're way over the line"
- 34 Tantrum while playing Xbox
- 35 Old conductance unit
- 36 Ice cream buys
- 38 Mmes., in Madrid
- 39 House-shaped browser button
- 40 School group
- 41 Puncture prefix
- 44 Each
- 46 Disco light
- 47 Passionate about
- 48 Passionate
- 51 Upper regions of space
- 52 "Likewise"
- 53 Blabbed about, in a way
- 55 World Cup cheers
- 57 Go __: succeed
- 58 Rite answer?
- 59 Short snooze
- 60 Bit of a draft?
- 61 Côte d'Azur saison

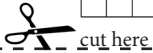

How to convince your co-workers to join in the fun.

Monkey see. Monkey do.

What stops us from doing certain things in public? Social acceptance. We don't want to do something that might seem weird or out of the ordinary.

But, how do we make play at work socially acceptable? Just do it. And do it confidently. Encourage others to join in. Once a few people are playing, others will take notice. The more people that join in, the more socially acceptable it becomes.

Use simple tasks or games to start with. Once people are comfortable with those, it should continue to snowball into more elaborate and incorporated forms of play.

Have the competitive type at your office? Find ways to assign points to games or activities and tally them up at regular intervals.

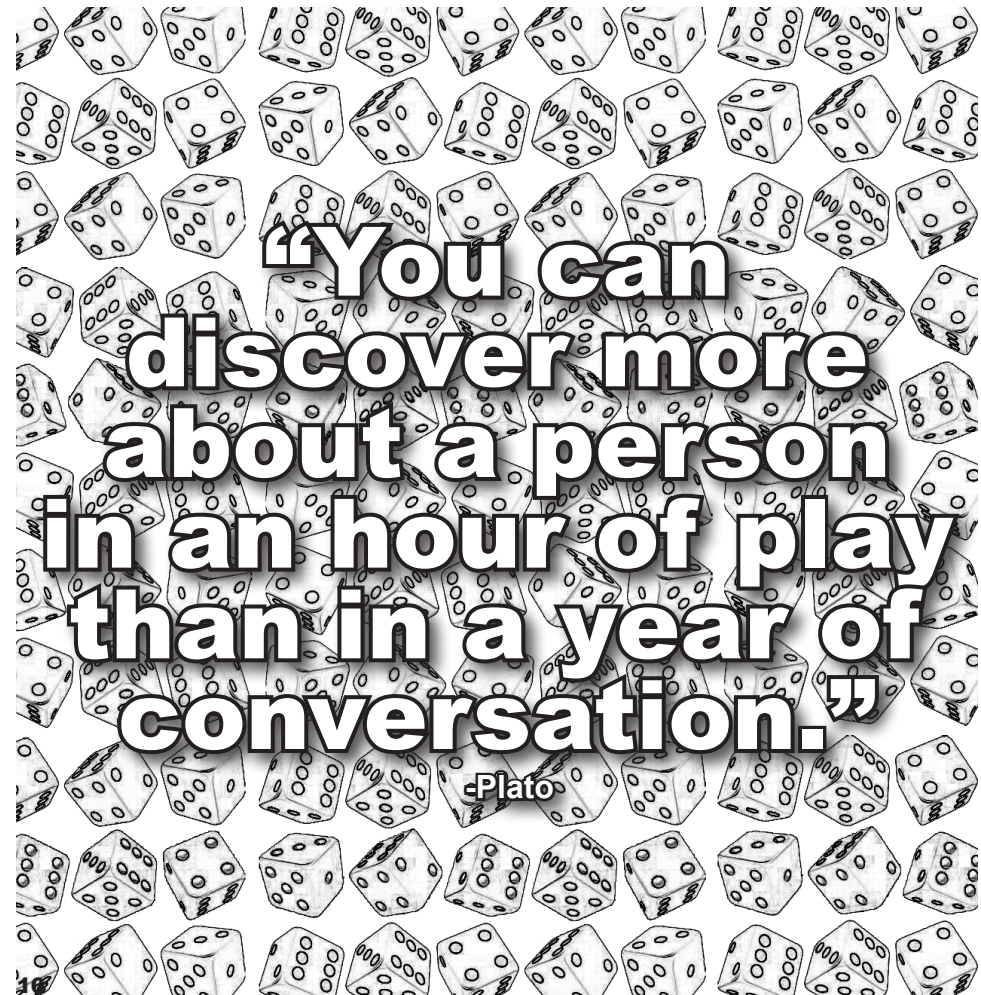
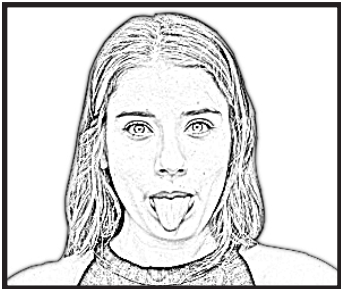
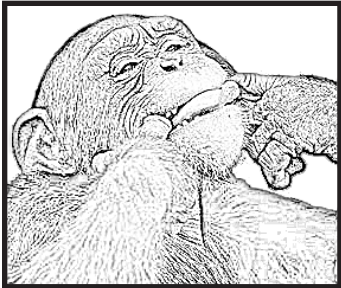

Attempt the puzzle.
+1 point

Finish the puzzle.
+2 points



cut here

Play Tip: PARTICIPATE!

Try to engage as many of your co-workers as possible. Play has even more benefits when more people participate. Creating stronger social bonds with your co-workers will only improve job performance and satisfaction.

Game Idea: Sticky Note Tag



Remember those “KICK ME” signs from school kids would put on other kids backs? Or what about playing tag?

This combines the two, but without physical abuse or getting all sweaty.

The game is simple. Just write out “Tag. You’re it!” on a sticky note and stick it to someone’s back. Or to the back of their chair. Or hide it somewhere in their desk. The point is that they not know it’s there right away.

Once it’s discovered, it’s now that person’s turn to find their unsuspecting victim. This, theoretically, could be the game that never ends...

Color in the pattern on the other side.

+2 points



cut here

Start Small. Take baby steps.

Getting a totally awesome video game arcade in the staff lounge is probably not going to be the first step to a playful work environment. It's going to be an adjustment for just about everyone.

Plant small, playful objects around the office to get people used to seeing these sorts of things. Start with a small set of blocks. Or a 3D puzzle. Adult coloring books are pretty easy to come by these days. Your first playful elements do not have to be revolutionary, but every revolution does have to start somewhere.

Let's mix it up!

Ideas on how to transform your boring, old conference room into the new and improved anti-conference room.

Want to make a bigger splash in your office? Try changing out a whole room! How about the conference room?

Every office has at least one and we are all pretty familiar with them. In the middle, there's an oversized table. It's usually big enough to make people on the other end seem pretty far away. The shape forces there to be a head of the table, which can totally kill a collaborative vibe. And the presentation wall is usually at one end or the other, causing everyone to strain their necks to see the screen. Outdated artwork and a marker stained whiteboard always make for nice finishing touches, too.

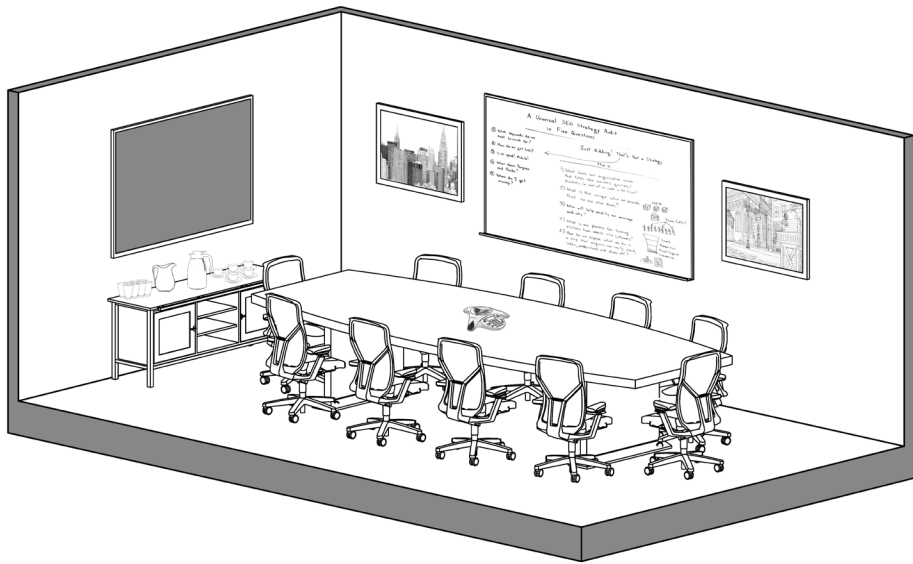
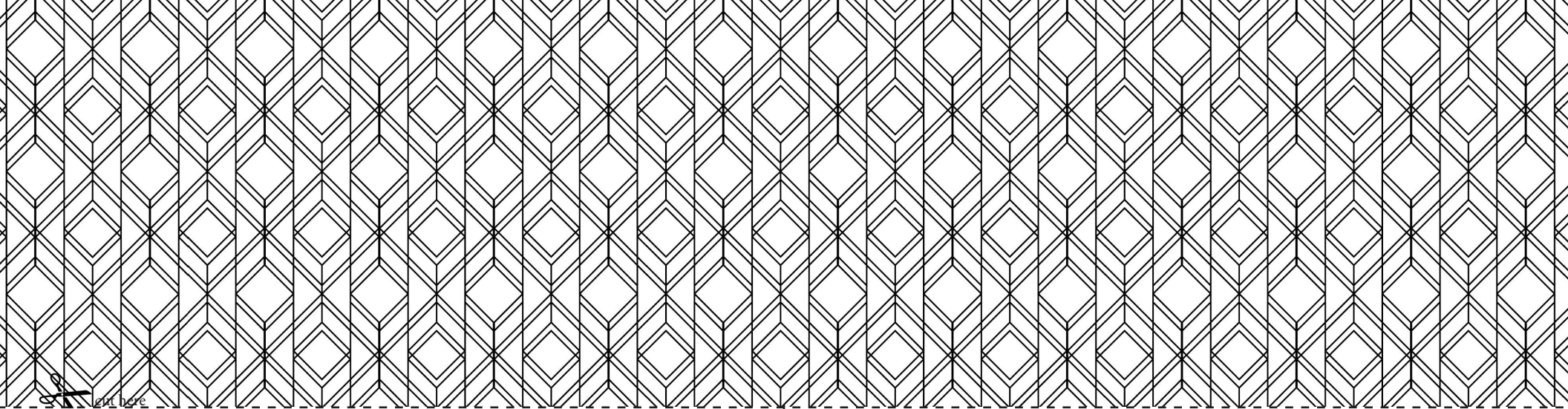

© #overworkedunderplayed

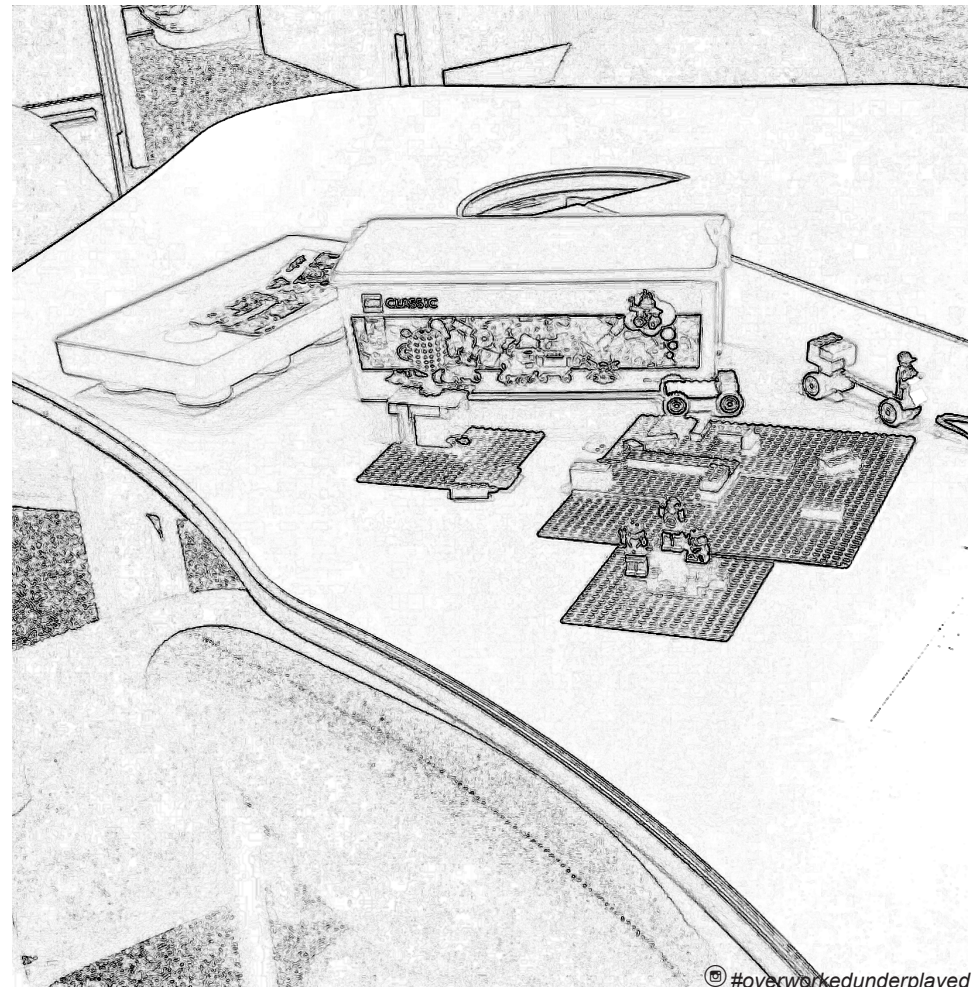

© #overworkedunderplayed

FINGER FOOTBALL

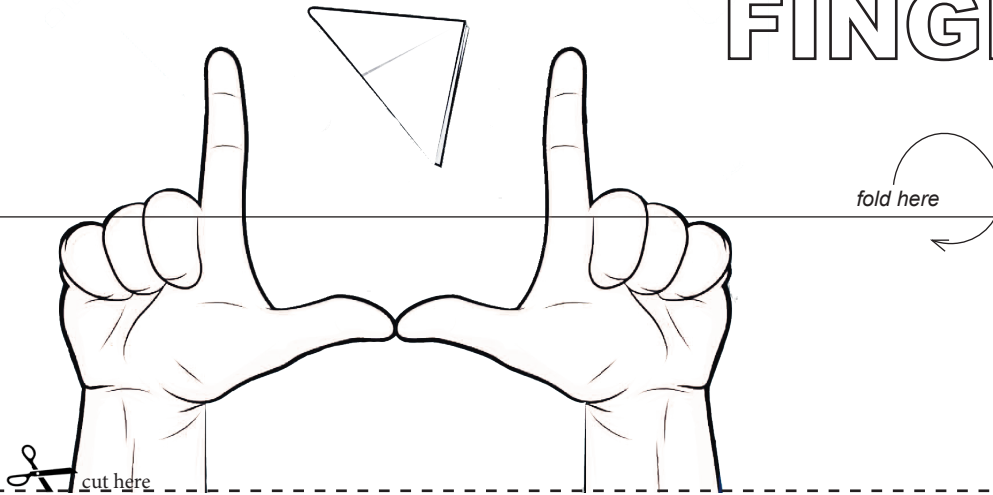

Fold your football.

+1 point

Get a co-worker to play with you.

+3 points

Step #1:

Strip your boring, old conference room down to a clean slate.

And, If convincing your boss didn't go as well as you had planned, just do the work yourself. Act first and ask for forgiveness later. Besides, what's the worst that can happen? Just get some of your co-workers to help you out. They can't fire all of you, right?!

Step #2:

Add some color, texture, fun!

When did the corporate motto become "Go beige or go home"? Add some colors that you wouldn't expect to see in an office. Why stop at adding color? What about patterns?! And, let's make sure it's *all* writable surface. No more single white boards at one end of the room.

While you're at it, change out the flooring in there, too! Make it something unexpected, like astro turf or really shaggy carpet.

If you want to keep some technology in there, make it centrally located in the room so people can gather around it rather than view it from a distance.

REMEMBER! This is not going to be your typical office environment. It should look *way* different than your other spaces.

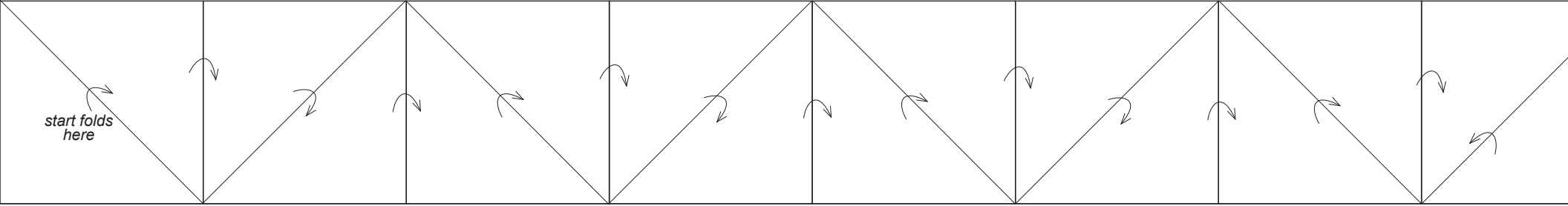

start folds here



cut here

tuck in
↓

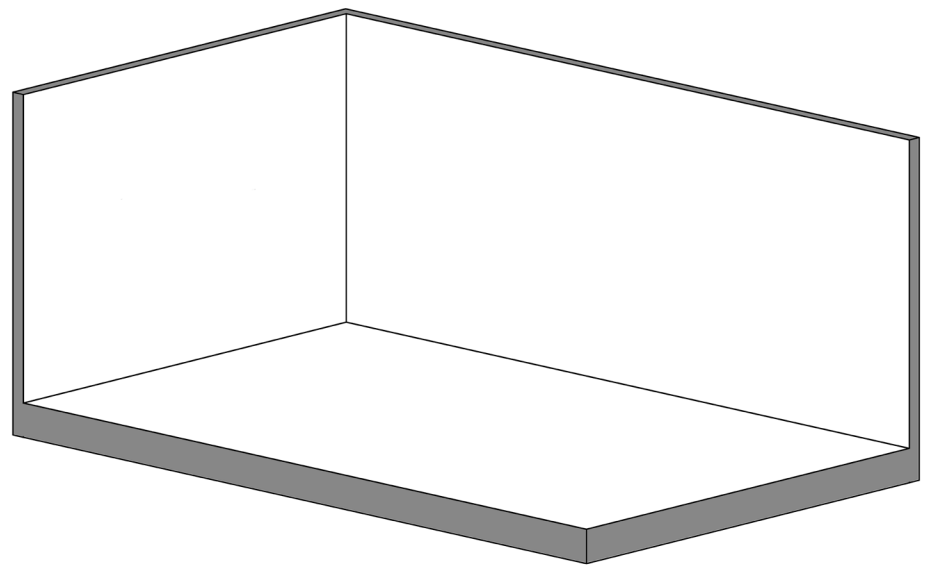
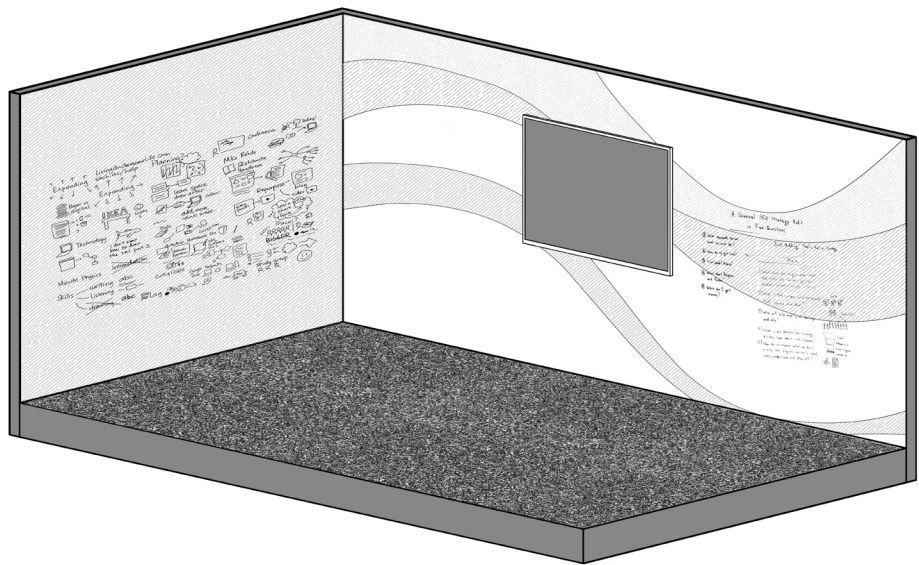

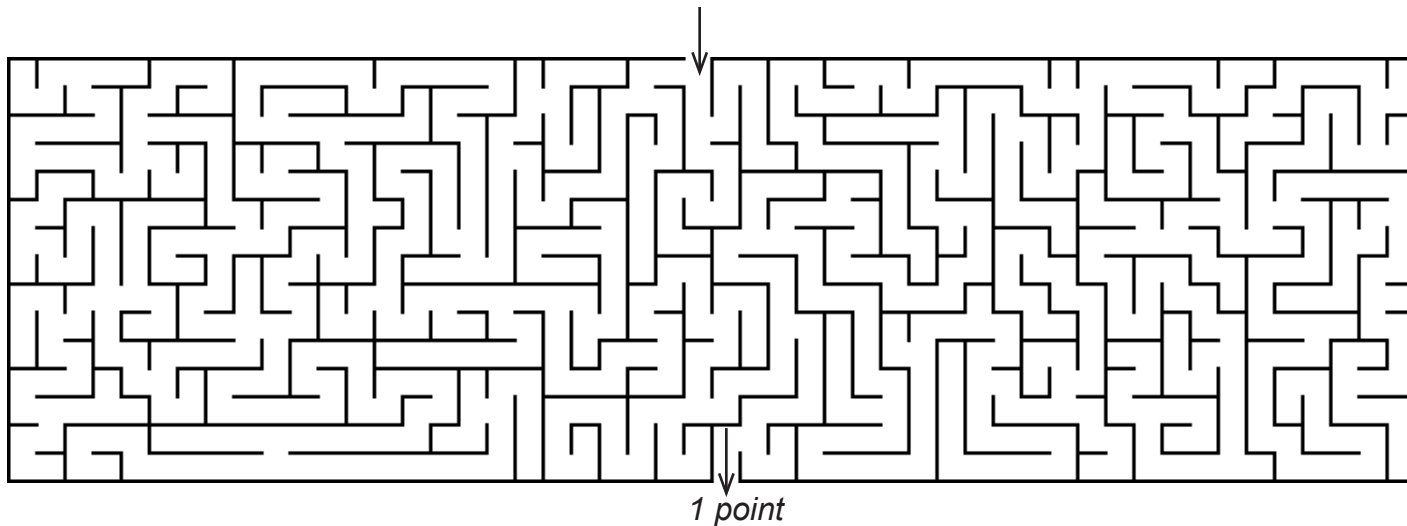

1 point

Step #3:

It's time to add some furniture.

Don't you DARE think about putting that clunky conference room table back in here. Furniture, in this case, is a pretty loose use of the term.

I'm talking: boxes that can stack, bean bag chairs, inflatable furniture, etc.

The only criteria: It can be moved easily and quickly. The point of this room is that it can be transformed into whatever space is needed at that moment.

Step #4:

Leave your "office attitude" at the door.

Set-up some rules for the space, but make them "anti" rules. For example: "In here, no one's the boss. Everyone is equal." Or what about, "Creativity is messy. Try not to be too clean." Even something simple. like, "Take off your shoes."

You want people to know that it's OK to work a little differently sometimes. Or maybe it's not even work at all. Maybe it's someone's birthday and celebrating in here would be way more fun than standing around someone's desk.

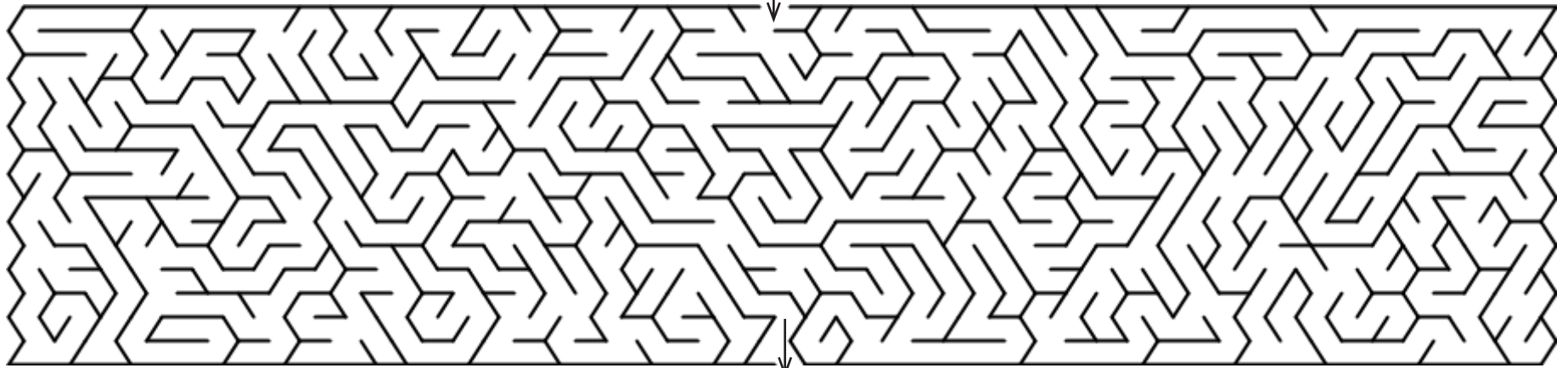

cut here

1 point

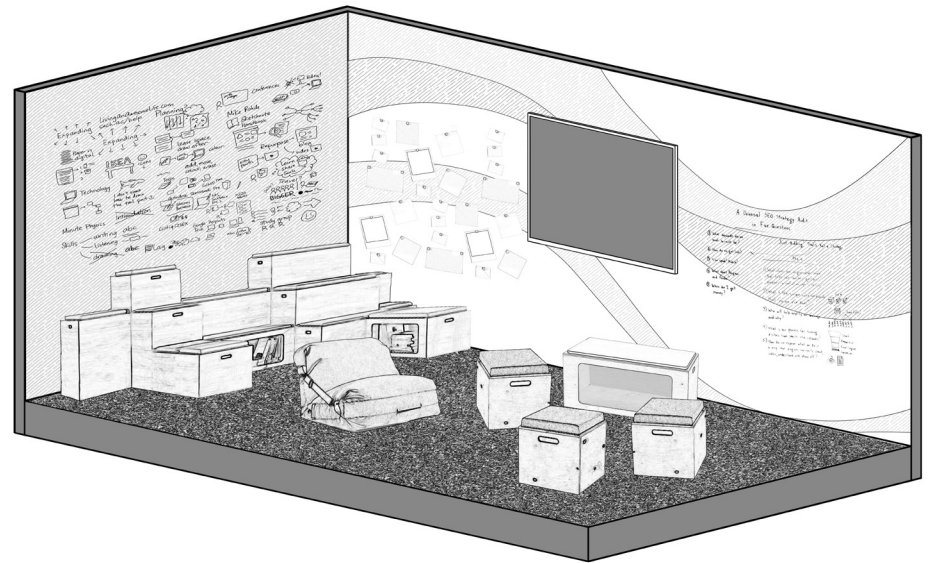
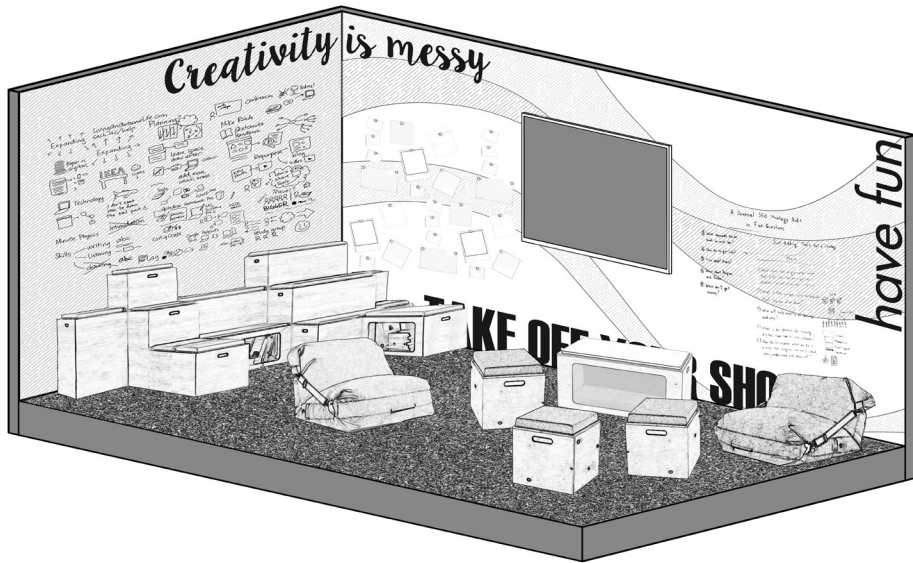

S N T D B R A U B E N S O U T H D A K O T A T O S E N N I M Q P T E X A S U W H
 P P N H Y J D N W I S C O N S I N B N A A F U A N Z Q F S I R U O S S I M E D P
 E G O A N I L O R A C H T R O N K I N E V A D A I E K R O Y W E N A D I R O L F
 N E G V J R D M T Q O N A G I H C I M D I K W I Q N W C F A Q D U N Y N R L Z O
 N O E D N A L Y R A M J M F P P L V A A D S A L P E R H N E B R A S K A A Q F Y
 S R R V G A M O H A L K O Q J O F Q R D M A S L O K U O A A A L N U M W D J A P
 Y G O W R A Y D W E S T V I R G I N I A U L H I H A L Z F M S D M D Z M B P V P
 L I X E M I K H A W A I I A W Y O M I N G A I N I N O S T I P P I S S I S S I M
 V A X N M N C T U C I T C E N N O C X D A U N O O S G H E R L S J U S E W E O B
 A N A I S I U O L Y C H S P O D A R O L O C G I W A A D A T F A H A N A T N O M
 N F A A G G T G U R T M A S S A C H U S E T T S F S O O E D O Z C I W J Z R H V
 I D P M B R N F L U O L A P W I N D I A N A O G P H S A W O I D Y H R R L A A L
 A A B V F I E A O I Y A L A B A M A I S H A N A R X L A R K A N S A S E T Y W N
 K W H H C V K S G Z E W M K I Y Y E S R E J W E N C O C I X E M W E N U B O Q M
 F Y K D P U U E E S S E N N E T H Z A T O K A D H T R O N U H V A N O Z I R A W



Step #5:

Break the space!

Take chances! Move some of the pieces (and ideas) of the anti-conference room and use them in other spaces. Allow for other areas to be more playful.

Slowly make some these “messy” spaces more visible. Make it part of the norm. The transformation should be organic, not forced or mandated.



**“Environments
 can be used not
 just to represent
 cultural values,
 but also to inspire
 them.”**

-Make Space, S. Doorley & S. Witthoft

ARKANSAS
TENNESSEE
KENTUCKY
NORTH CAROLINA
SOUTH DAKOTA
INDIANA
MINNESOTA
ARIZONA
WISCONSIN
ALABAMA

CALIFORNIA
MONTANA
ALASKA
ILLINOIS
NORTH DAKOTA
MARYLAND
VERMONT
PENNSYLVANIA
RHODE ISLAND
NEW HAMPSHIRE

SOUTH CAROLINA
VIRGINIA
CONNECTICUT
MICHIGAN
NEW MEXICO
NEVADA
IDAHO
FLORIDA
GEORGIA
WASHINGTON

LOUISIANA
NEW JERSEY
HAWAII
COLORADO
WYOMING
IOWA
WEST VIRGINIA
UTAH
NEBRASKA
MISSISSIPPI

OHIO
MASSACHUSETTS
DELAWARE
OREGON
OKLAHOMA

Find all
the words.
+1 point



cut here

Play Tip: It takes just a few minutes!

Our brains start gaining the benefits from play almost immediately. A misconception of play is that it *has* to be a game that takes a long time to complete. While some play like this is important, we can't take hours out of our day at work. But, we can take minutes. Give yourself little 5 minute breaks throughout the day.

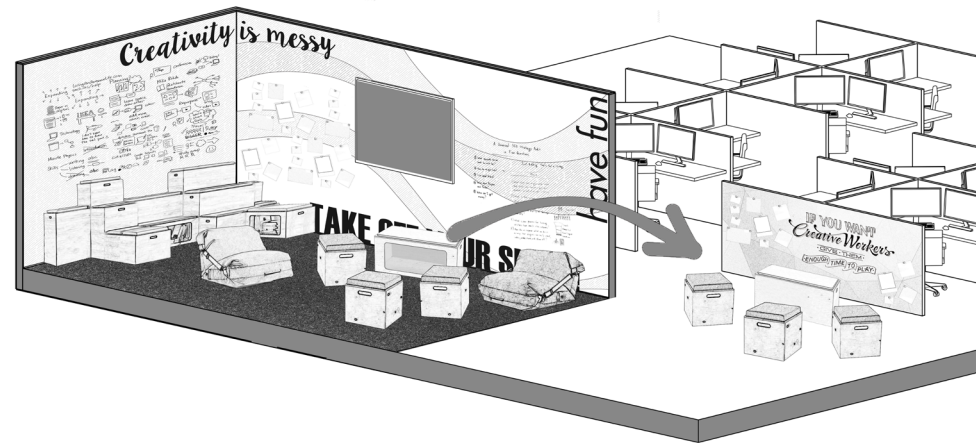

FOLD THE PIGEON

2 points

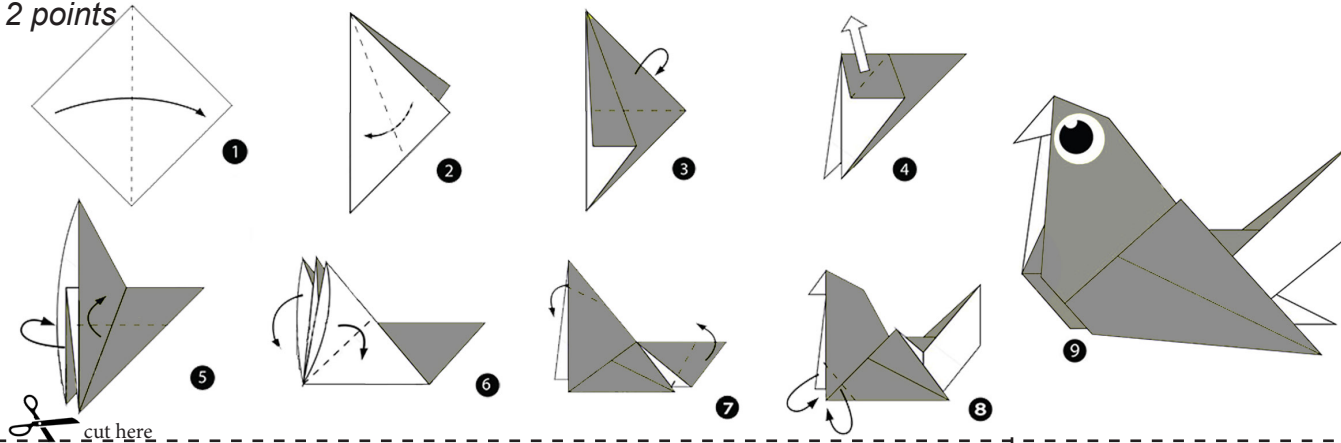

Use this square to
make your pigeon.

First, color it in!
+1 point!



FINAL THOUGHTS? IDEAS?

Did you make a pigeon yet?

+1 point



cut here

Play Tip: IT'S NOT GOING TO HAPPEN OVERNIGHT.

You know what they say, "You can't teach an old dog new tricks." Well, that's essentially what you are attempting to do. Change old work habits. This means, you're in for the long haul.

Our work culture did not get where it is today because somebody just said it would be so. The circumstances that have gotten us here have a pretty long history. And you probably aren't going to undo a century plus of conditioning with one game in your office.

My advice. Patience. It's going to be hard sometimes. You are going to get resistance, more than you would like, I'm sure. But, hang in there. You've got this. Continue to set examples. I am confident that, one day, some day, people will come around and see how great play in the workplace can be.

DON'T FORGET
TO SHARE!

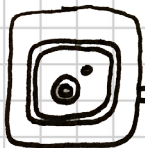

#overworkedunderplayed

Nicole Lindemer
Advanced Design Studio 2 - Game of Life
Lawrence Technological University

© #overworkedunderplayed

© #overworkedunderplayed