

# Exploded View

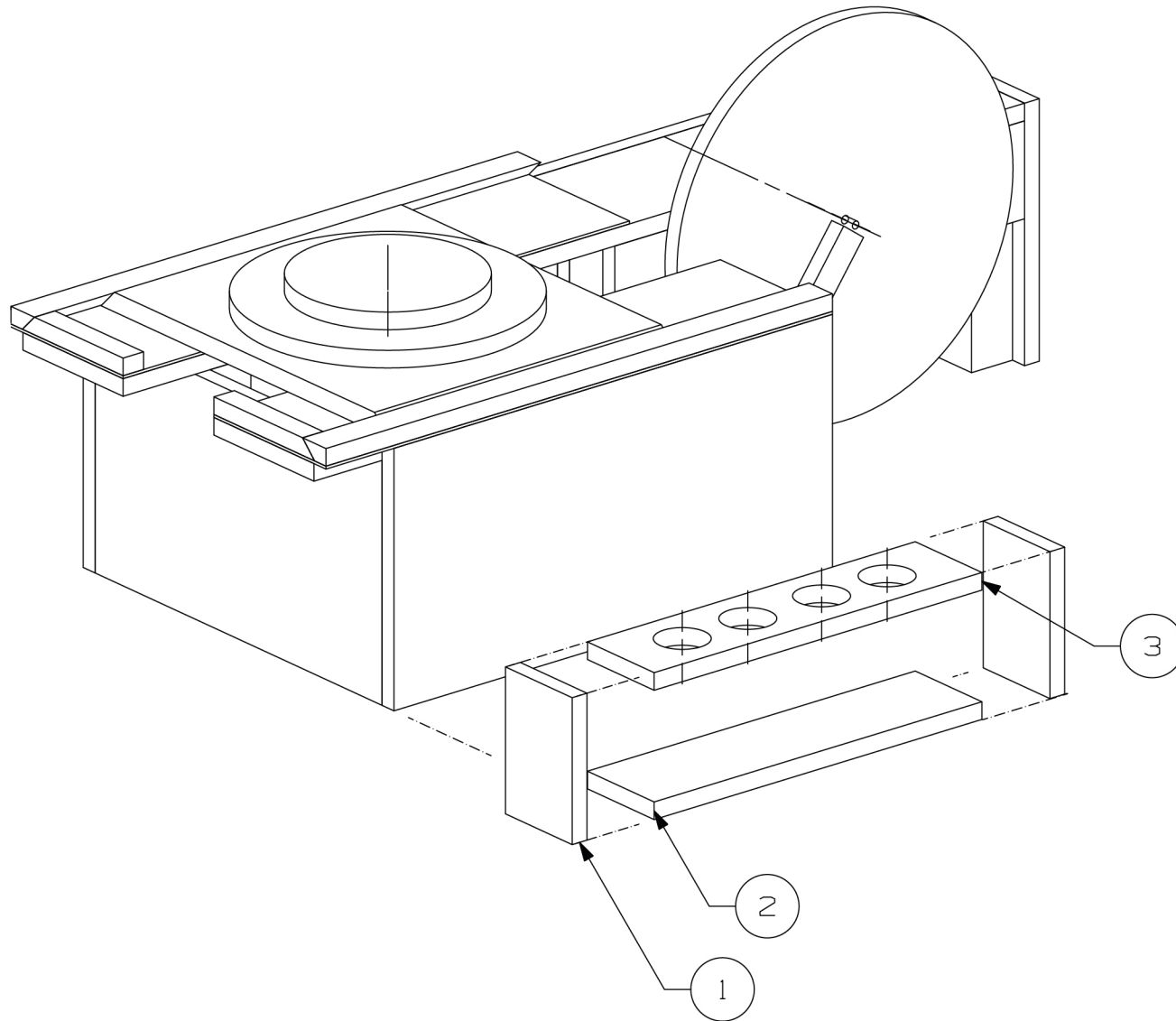

3	VERFREK_PLAA T MET GATEN	1
2	VERFREK_ONDE RPLAAT	1
1	VERFREK_ZIJP LATEN	2
PC NO	PART NAME	QTY

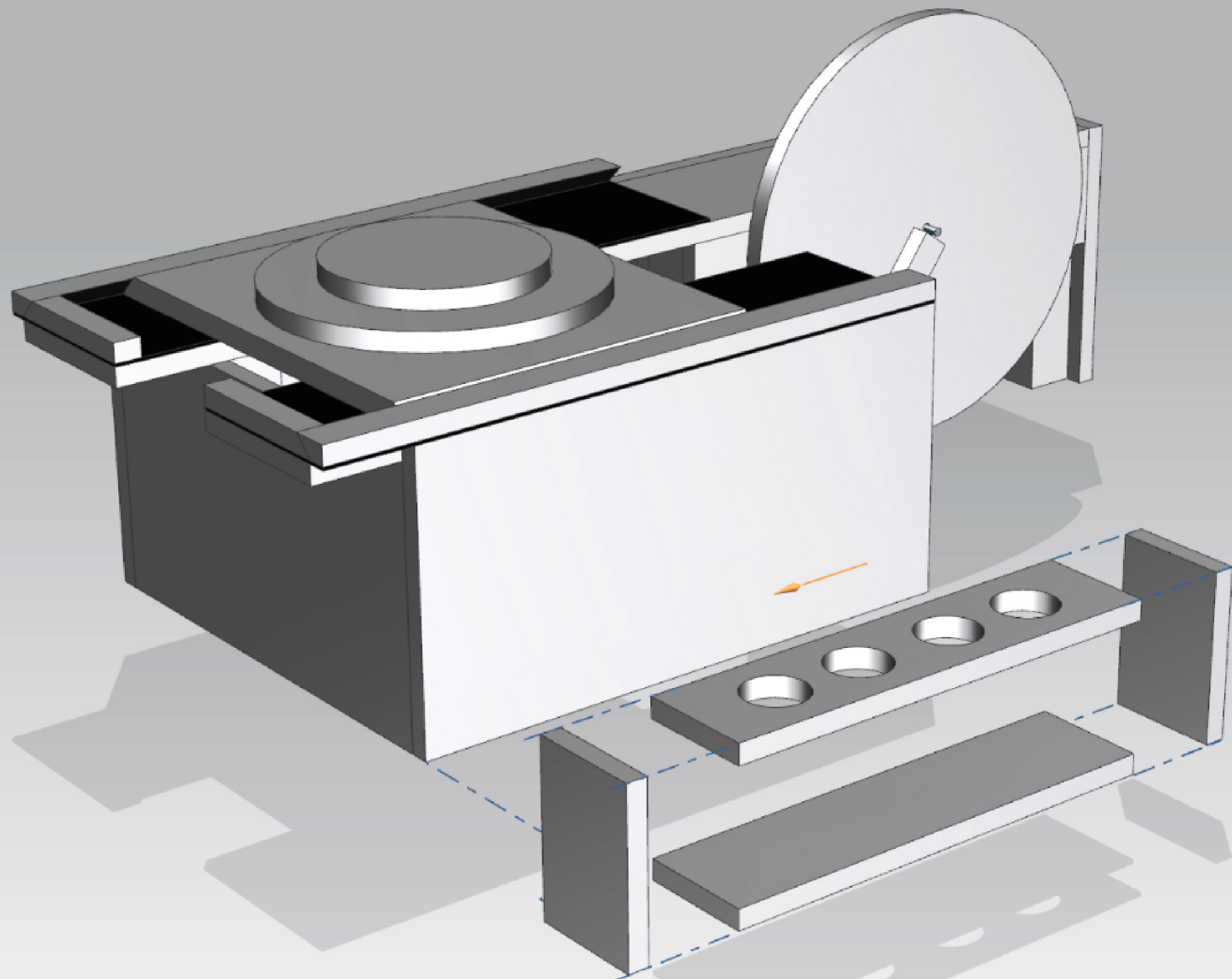

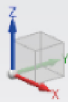
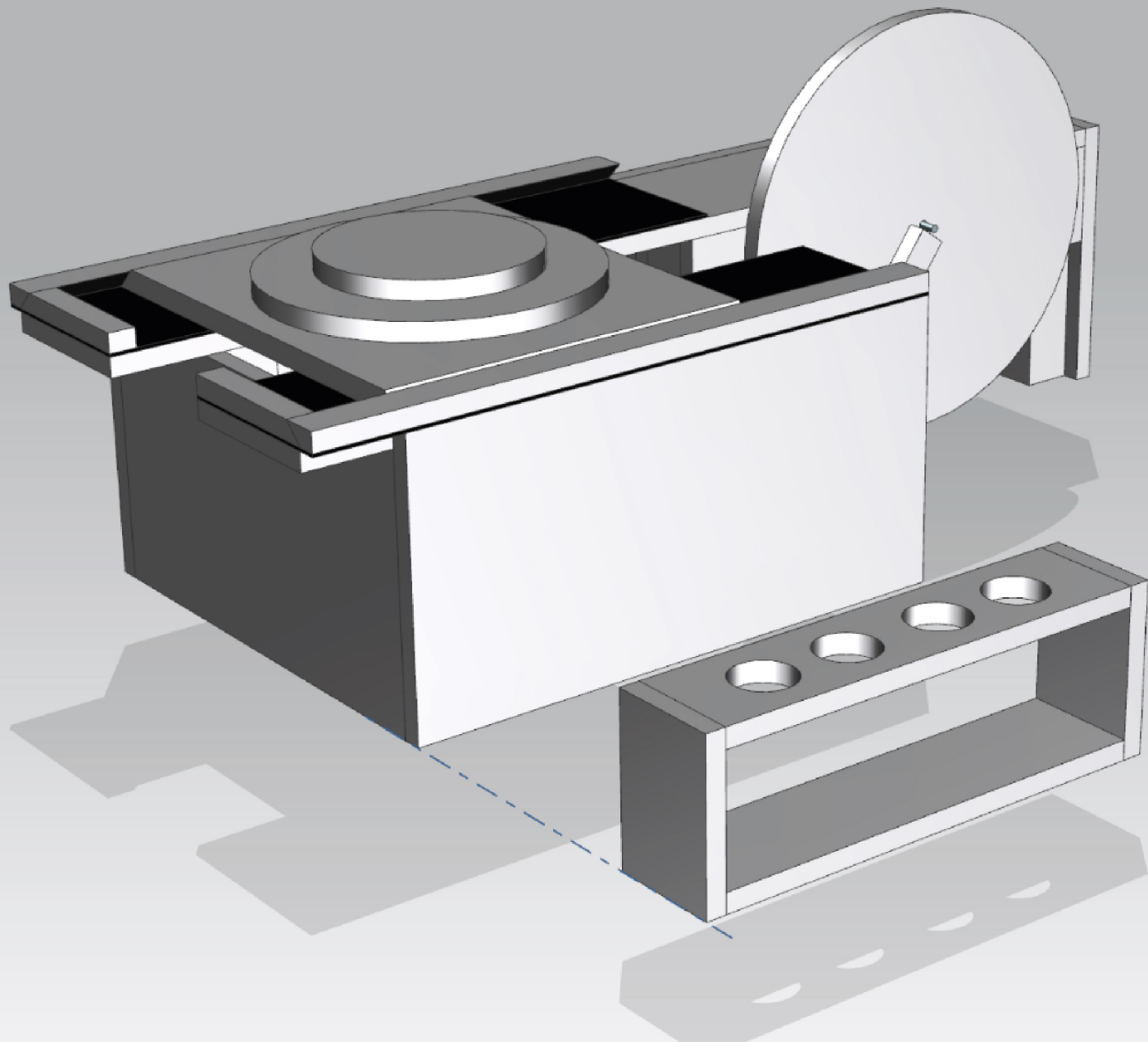

1.

Thickness 18

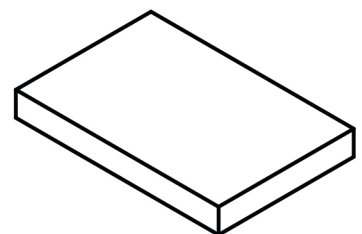
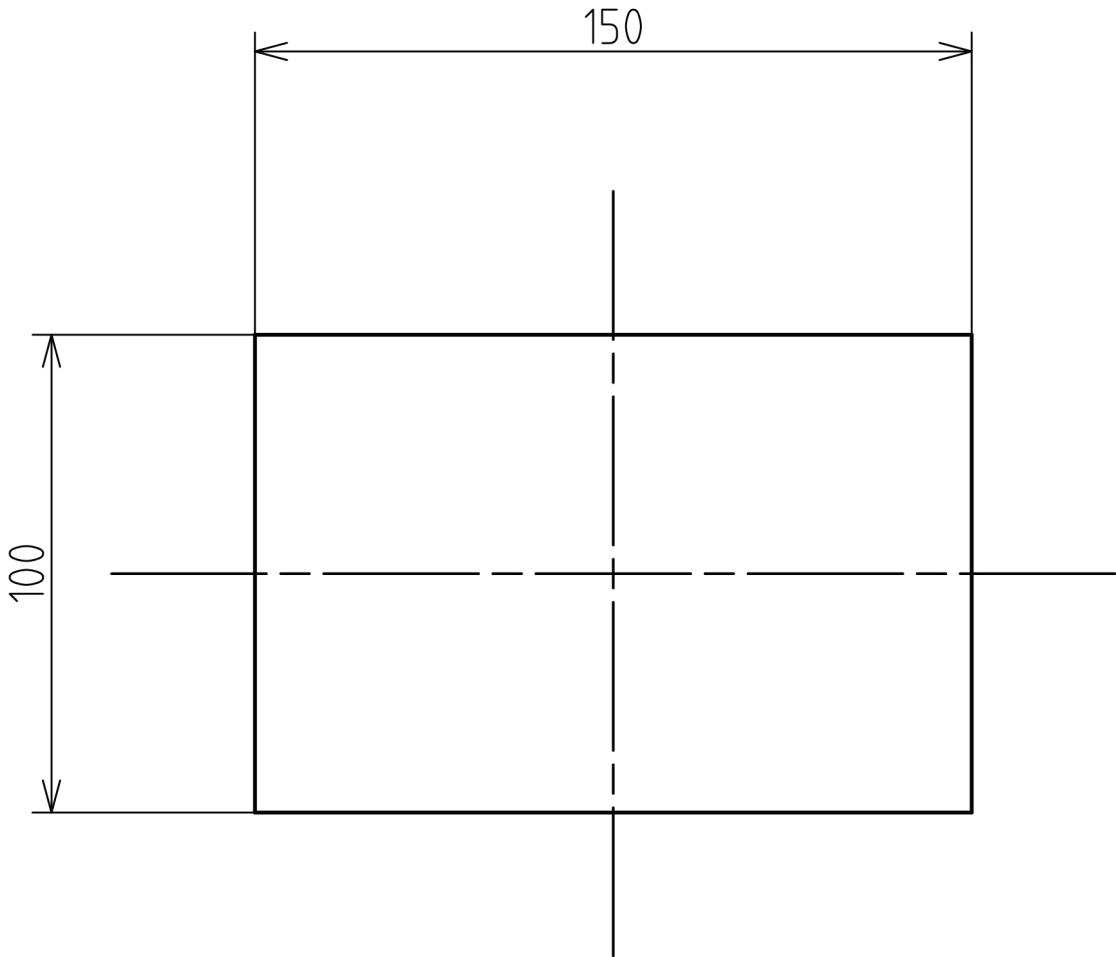

2.

Thickness 18

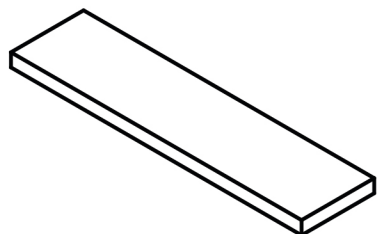
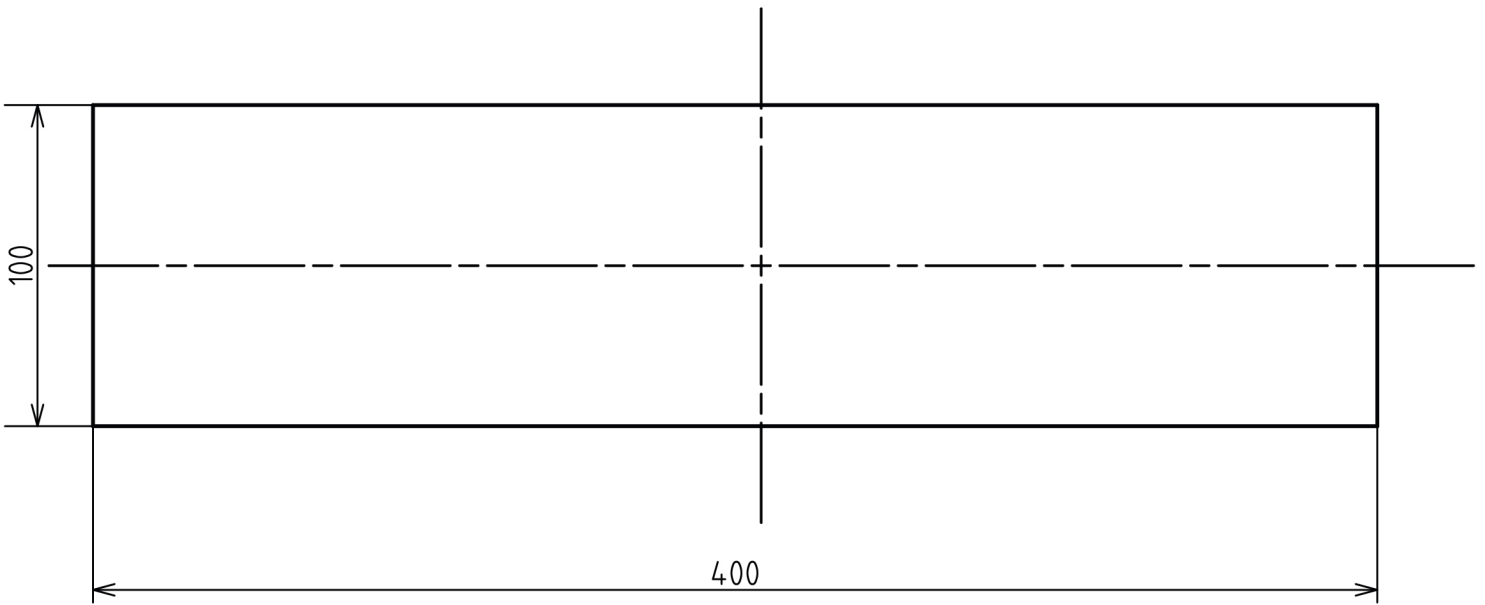

3.

