

작품명	24h시계-등각투상도	각법	NS
		척도	1:3

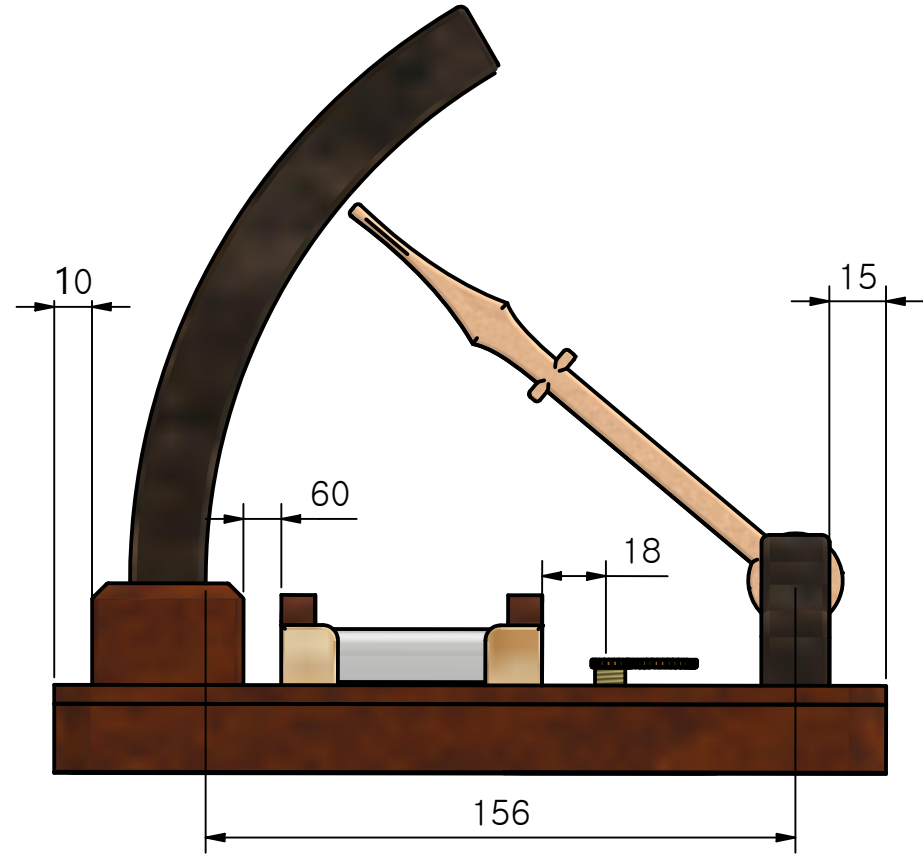

작품명	24h시계-등각투상도	각법	삼각법
		척도	1:2

① 건전지:1

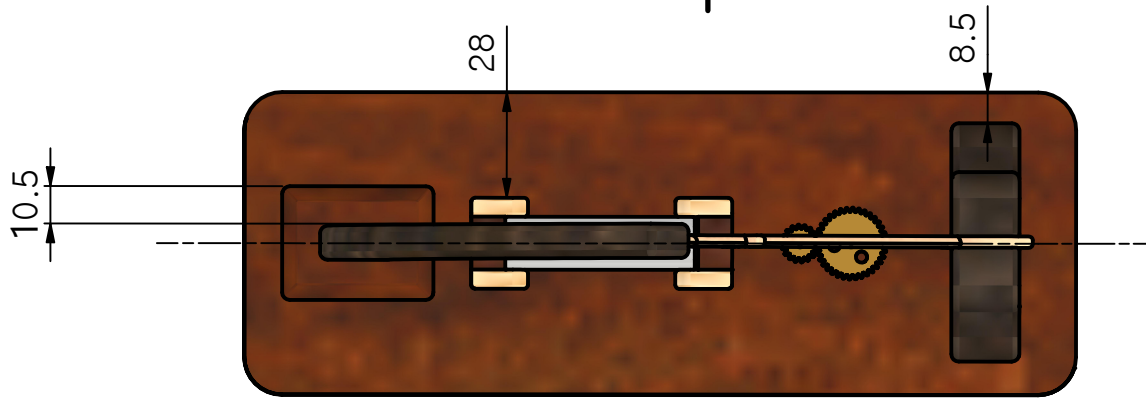
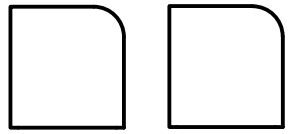

5T

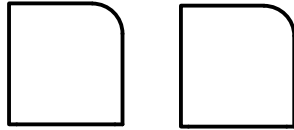

② 건전지:2



9T

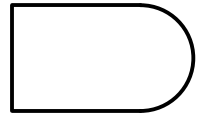

③ 바늘 지지

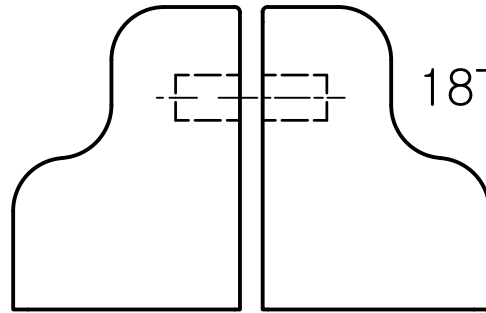

18T

a pattern for drilling

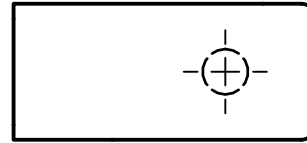
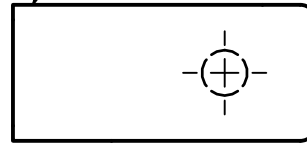

④ 표지판 지지대

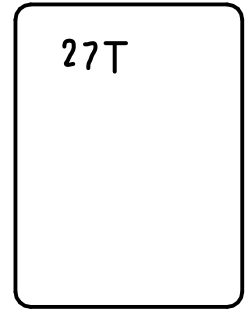

27T

⑥ 표지판 9T

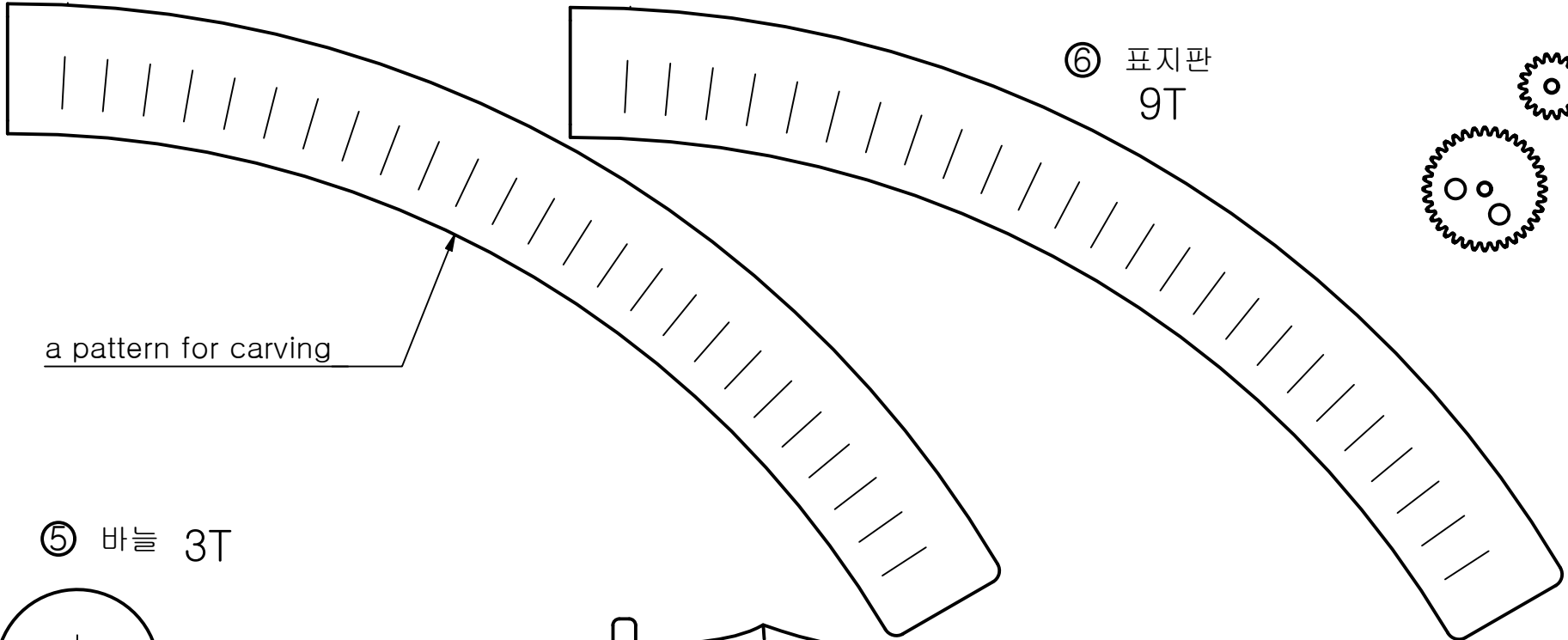

a pattern for carving

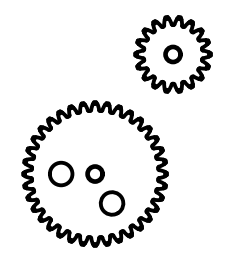

⑤ 바늘 3T

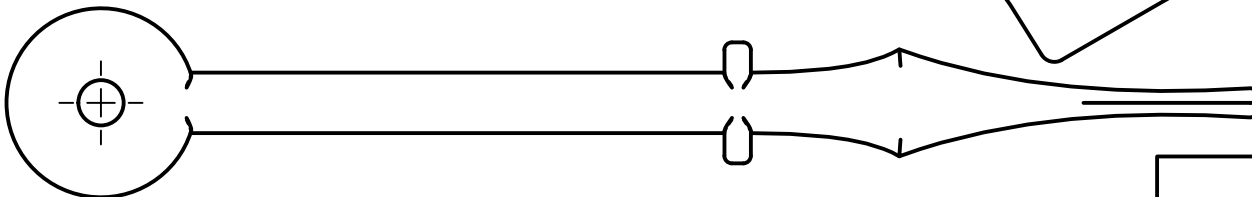

작품명	24h시계-pattern_1	각 법	삼각법
		척 도	1 : 1

⑦ 본체 윗판  
5T

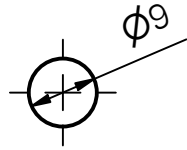

⑧ 본체 아랫판  
18T

작품명

24h시계-pattern\_2

각 법	삼각법
척 도	1 : 1